



NO.
01
2023

RÖSSLER

— 1937 —



german
brand
award
21
winner



PAPIER · DESIGN · MANUFAKTUR

PAPER · DESIGN · HANDCRAFT | PAPIER · DESIGN · MANUFACTURE



RÖSSLER
- 1937 -

PAPIERVERLIEBT SEIT 1937. STILSICHER IN NEUE ZEITEN.

IN LOVE WITH PAPER FOR GENERATIONS. INTO THE FUTURE WITH STYLE.

AMOUREUX DU PAPIER DEPUIS DES GÉNÉRATIONS. AVEC STYLE DANS UNE ÈRE NOUVELLE.



german
brand
award
21
winner



NATURVERBUNDEN SEIT 1937

CLOSE TO NATURE SINCE 1937

PROCHE DE LA NATURE DEPUIS 1937

Papier ist der Mittelpunkt unserer täglichen Arbeit und die Basis unserer Produkte. Wir leben sozusagen mit Papier. Seit der Gründung von Rössler Papier im Jahr 1937 inspirieren uns die vielseitigen Eigenschaften dieses Naturrohstoffs.

Ressourcenschonend und verantwortungsvoll zu wirtschaften, ist Kernbestandteil unserer Philosophie als Familienunternehmen. Wir legen deshalb großen Wert auf den Einsatz von zertifizierten Papieren und freuen uns, immer mehr Natur- und Recyclingpapiere in unser Sortiment aufnehmen zu können.



So zieht sich das Thema „Natur“ 2023 in besonderer Weise wie ein roter Faden durch unsere verschiedenen Sortimentsbereiche.

Wir wünschen Ihnen viel Freude beim Lesen dieses Katalogs!

Herzlichst
Ihre Familie Rössler-Ehlers

As a family-owned company, conserving resources and operating responsibly is a core component of our corporate philosophy. We therefore attach great importance to the use of certified papers and are pleased to be able to include more and more natural and recycled papers in our range.

In 2023, the theme of "nature" runs like a red thread through our various product ranges. We hope you enjoy reading this catalogue!

Sincerely
Your family Rössler-Ehlers

En tant qu'entreprise familiale, la conservation des ressources et l'exploitation responsable sont au cœur de notre philosophie d'entreprise. Nous attachons donc une grande importance à l'utilisation de papiers certifiés et sommes heureux de pouvoir inclure de plus en plus de papiers naturels et recyclés dans notre gamme.

En 2023, le thème de la "nature" court comme un fil rouge à travers nos différentes gammes de produits. Nous vous souhaitons une bonne lecture de ce catalogue!

Cordialement
Votre famille Rössler-Ehlers

Notes
& more
notes



INHALTSVERZEICHNIS · CONTENTS · SOMMAIRE

NATURVERBUNDENHEIT SEIT 1937	4–5	SCHÖNE FESTE	152–167
BUNTE PAPIERWELT	6–43	Baby – Girl	154
Paperado	8	Baby – Boy	156
Creative Shop	22	Kommunion/Konfirmation – Johanna	158
Fine Paper	26	Kommunion/Konfirmation – Johannes	159
Rössler Bütten Packware	31	Hochzeit – Simply Love	160
Designpacks	32	Hochzeit – Love is in the air	164
Designblätter	34	Hochzeit – Pure Love	166
Kreativblätter	39	Hochzeit – Two Hearts	167
Twin Papers	40	FOTO	168–183
Glitter Papers	42	Rückwand-Präsentation	170
KREATIV-ACCESSOIRES	44–97	Fotoprodukte	171
Creative Shop	46	Fotoalben Wire-O	172
Tags & Buttons	50	Foto-Ringbücher	173
Garne	52	Foto-Notizbücher	175
Bänder	55	Fotoalben Wire-O – mit Motiv	176
Boxen	56	Fotoalben mit verdeckter Wire-O-Bindung	177
Creative Tapes	58	Colour Frames Bilderrahmen	180
Hanging Tapes	62	Gästebücher	182
Stempel & Stempelkissen	64	EDLES SCHREIBEN	184–221
Stempel May & Berry	65	Mappen und Kassetten	
Stempel & Stempelkissen Vintage	67	Paper Royal	186
Handmade Stickers Neuheiten	69	Rössler Bütten	188
Handmade Paper Stickers	75	Signature	190
Handmade Stickers	76	Rückwand-Präsentation	192
Peel-Off Stickers	96	Korrespondenzpapiere	
ORDNEN MIT STIL	98–119	Paper Royal	194
S.O.H.O. Classic Rib	104	Edel Satin	196
S.O.H.O. Natural Line	110	Edel Leinen	197
S.O.H.O. Special Line	114	Edelbütten	198
PAPETERIE	120–151	Dürener Tradition	199
Wiesenblumen	122	Rössler Bütten	200
Gras	126	Rössler Bütten Packware	201
Tilly	128	Inspiration	202
Tilly Green	131	Reflex	202
Botanicals	133	Bütten	203
Lavendel	136	Excellent	204
Summer Vibes	138	Brillantleinen	205
Easy Planning	142	Trauerpost	206
Natural Lettering	144	Terra Naturpapiere	208
Magic Moments	145	Designblöcke	210
Notizbücher My Journal	146	Designpacks	211
Notizbücher	148	Briefpapierpackungen	213
Foto-Notizbücher	149	Karten	219
Notizhefte	150	VERPACKEN & SCHENKEN	222–241
		Boxline	224
		Boxline Metallic	226
		Kartonagen	227
		Sammelboxen	232
		Geschenkpapier	233
		Geschenktaschen & Flaschenbeutel	236

NATURVERBUNDEN & VERANTWORTUNGSVOLL



© kaj – stock.adobe.com

DER NATIONALPARK EIFEL ALS QUELLE

Seit Jahrhunderten besteht in unserer Heimatstadt Düren, der „Papierstadt“, eine besonders enge Verbindung zwischen Natur und Industrie. Am Fuße des Nationalparks Eifel gelegen ist es das besonders „weiche“, also kalkarme, Wasser des hiesigen Flusses – der Rur – das dazu führte, dass sich Düren seit 400 Jahren zu einem führenden Papierzentrum in Deutschland entwickelt hat. Wir sind stolz, ein Teil davon zu sein.

For centuries, there has been a particularly close connection between nature and industry in our home town of Düren, the „paper town“. We are proud to be a part of it.

Depuis des siècles, il existe un lien particulièrement étroit entre la nature et l'industrie dans notre ville natale de Düren, la „ville du papier“. Nous sommes fiers d'en faire partie.



© Tyler Olson – stock.adobe.com

IM URSPRUNG MIT DER NATUR VERBUNDEN

Seit 1937 haben wir uns dem Naturrohstoff Papier verschrieben. Papier fasziniert uns mit all seinen Facetten und vielfältigen Anwendungsmöglichkeiten. Papier „lebt“ und wir leben mit Papier. Die Natürlichkeit von Papier inspiriert uns – jeden Tag aufs Neue.

Paper „lives“ and we live with paper. The naturalness of paper inspires us - every day anew.

Le papier „vit“ et nous vivons avec le papier. Le caractère naturel du papier nous inspire chaque jour.



HEUTE FÜR ÜBERMORGEN

Als Familienunternehmen mit mehr als 85-jähriger Tradition denken und handeln wir langfristig – immer mit einer generationsübergreifenden Perspektive. Wir setzen auf nachhaltige Produktionsstandards am Standort Deutschland und in unserem Tochterwerk in Tschechien. So können wir faire Arbeitsbedingungen und kurze Transportwege garantieren.

We rely on sustainable production standards at our site in Germany and at our subsidiary in the Czech Republic.

Nous misons sur des normes de production durables sur notre site en Allemagne et dans notre filiale en République tchèque.



IM NATUR-KREISLAUF

Rössler verarbeitet Papiere zertifiziert nach FSC® und ist zudem als Unternehmen FSC®-zertifiziert. So tragen wir dazu bei, Wälder für zukünftige Generationen zu erhalten und die Interessen von Menschen und Tieren, die in oder von diesen Wäldern leben, zu schützen. Besondere Natur- und Recyclingmaterialien machen einen stetig wachsenden Anteil unseres Sortiments aus. Ausschuss, der während unserer Papierverarbeitung entsteht, wird dem Recycling-Kreislauf zugeführt.

Rössler processes papers certified according to FSC® and is also FSC®-certified as a company. Special natural and recycled materials make up a steadily growing proportion of our range.

Rössler utilise des papiers certifiés FSC® et est également certifiée FSC® en tant qu'entreprise. Les matériaux naturels et recyclés particuliers représentent une part toujours plus importante de notre assortiment.

Der Hintergrund zeigt den Rursee in der Eifel



BUNTE PAPIERWELT VIELFALT ERLEBEN

Außergewöhnliche Qualitäten, faszinierende Farben und vielfältige Formate zeichnen dieses Kernsortiment von Rössler aus. Zum Schreiben, Drucken und zum kreativen Gestalten – für alle, die es persönlich und individuell lieben.

Extraordinary qualities, fascinating colours and diverse formats characterise this core range from Rössler. For writing, printing and creative design.

Des qualités exceptionnelles, des couleurs fascinantes et des formats variés caractérisent cette gamme principale de Rössler. Pour l'écriture, l'impression et la création.





AUSDRUCKSSTARKE GERIPPT PAPIERE

Charakteristisch für das Paperado-Sortiment ist die edle Rippung in der Oberflächenstruktur des Papiers. Diese verleiht den Produkten ihre angenehme Haptik und den ausdrucksstarken Charakter. Dadurch erhalten die gerippten Paperado-Papiere eine besonders hochwertige Anmutung.

Characteristic of the Paperado range is the fine ribbing in the surface structure of the paper. This gives the products their pleasant feel and expressive character.

La caractéristique de la gamme Paperado est le noble vergure de la structure du papier. Cela donne aux produits une agréable sensation et leur caractère expressif.

URSPRÜNGLICHE NATURPAPIERE

Naturpapiere aus dem Paperado-Sortiment setzen den natürlichen Charakter des Rohstoffs Papier in den Fokus. Gezielt werden die einzelnen Inhaltsstoffe der Papiere optisch zur Geltung gebracht. So erzählen diese Naturpapiere jeweils ihre ganz eigene Geschichte – wie z. B. die beiden neuen Naturpapiere „Kakao“ und „Mais“.

Natural papers from the Paperado range focus on the natural character of the raw material paper. The individual ingredients of the papers are visually accentuated.

Les papiers naturels de la gamme Paperado se concentrent sur le caractère naturel de la matière première du papier. L'aspect naturel du papier est particulièrement accentué.







ELEGANTE METALLIC-PAPIERE

Ausgewählte Paperado-Faben sind in einer hochwertigen Metallic-Qualität erhältlich. Die besondere Oberfläche verleiht den Papieren einen metallisch-schimmernden Effekt, der diese Papiere ausgesprochen elegant wirken lässt.

Selected Paperado colours are available in a high-grade metallic quality. The special surface gives the papers a shimmering effect.

Les couleurs Paperado sélectionnées sont disponibles dans une qualité à l'aspect métallique de haute qualité. La surface spéciale donne à ces papiers un effet brillant.



PAPERADO

BUNT. VIELFÄLTIG. KREATIV.

Paperado ist die wunderbare Welt der farbigen Papiere. Außergewöhnliche Qualitäten, faszinierende Farben und vielfältige Formate zeichnen dieses Kernsortiment von Rössler aus. Über Jahrzehnte hinweg hat sich Rössler zum Spezialisten auf diesem Gebiet entwickelt. Für uns machen feine Details den Unterschied – am Produkt selbst, in der Präsentation und im Kundenservice.

Paperado is the wonderful world of coloured papers: exceptional qualities, fascinating colours and diverse formats.

Paperado, c'est le monde merveilleux des papiers colorés: des qualités exceptionnelles, des couleurs fascinantes et des formats variés.



Das Zeichen für verantwortungsvolle Waldwirtschaft



VIELFALT IN FARBE UND FORM

Mehr als 40 Farben sind in rund 30 Formaten erhältlich. Paperado-Farben kommen nicht von der Stange, sondern werden eigens nach unseren Spezifikationen angefertigt. Das Farbspektrum wird jährlich aktualisiert und um aktuelle Trendfarben ergänzt.

Paperado offers more than 40 colours in around 30 formats.
Paperado propose plus de 40 couleurs dans une trentaine de formats.



QUALITÄT „MADE IN GERMANY“

Alle Paperado-Produkte werden am Firmensitz in Düren entwickelt. Wir sind stolz auf die Produktion am eigenen Standort, die von großem technischem Know-how und viel Erfahrung geprägt ist.

All Paperado products are developed at the company headquarters in Düren. We are proud of the production at our own site.
Tous les produits Paperado sont développés au siège de l'entreprise à Düren. Nous sommes fiers de la production sur notre propre site.



KREATIV-SORTIMENTE

Wir bieten ein breites Spektrum an ergänzenden Produkten. Von Stickern über Stempel, Garne, Tapes bis hin zu Kreativ- und Feinpapieren verschiedenster Qualitäten.

We offer a wide range of complementary products: From stickers to stamps, yarns and tapes to creative and fine papers.
Nous proposons un large éventail de produits complémentaires: Des stickers aux tampons, des fils aux tapes en passant par les papiers créatifs et fins.



KARTEN-WERKSTATT

Die Karten-Werkstatt ist eine Online-Plattform mit vielfältigen Inspirationen zum kreativen Gestalten. Zu jedem Kartenbeispiel gibt es ein Erklärvideo mit einer Schritt-für-Schritt-Anleitung.

“The card workshop” is an online platform giving numerous inspiration for creative design.
“L'atelier de cartes” est une plate-forme en ligne qui propose des inspirations variées pour la création.



ATTRAKTIVE FLÄCHENRENTABILITÄT

Paperado ermöglicht dem Handel überdurchschnittliche Margen und Flächenrentabilitäten. Gestalten Sie Ihren Erfolg mit Paperado!

Paperado enables retailers to achieve above-average margins and profitability per unit area. Create your success with Paperado!

Paperado permet aux commerçants de réaliser des marges et des rentabilités de surface supérieures à la moyenne. Construisez votre succès avec Paperado!



PRÄSENTATION MIT FERNWIRKUNG

Unsere ausgereiften Präsentationssysteme setzen das Sortiment optimal und selbsterklärend in Szene. In den Schaukästen sprechen farbige Hintergründe mit emotionalen Fotos und darauf abgestimmte Musterkarten den Endverbraucher direkt an.

Our sophisticated presentation systems optimally display each assortment and offer self-explanatory orientation at the point of sale.

Nos systèmes de présentation sophistiqués mettent en scène l'assortiment de manière optimale et offrent une orientation auto-explicative dans les magasins.





BUNTE PAPIERWELT PAPERADO FARBEN

COLOURS · COULEURS

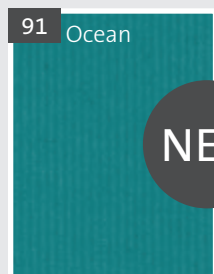
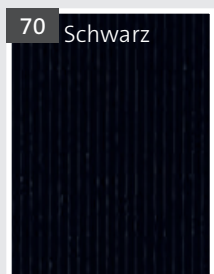
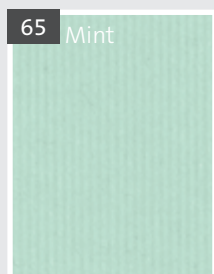
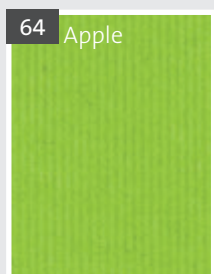
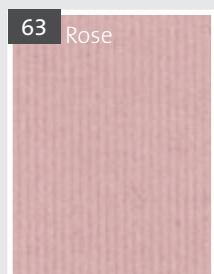
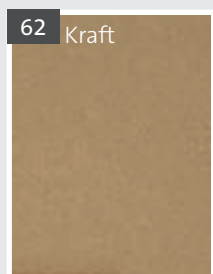
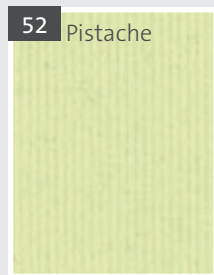
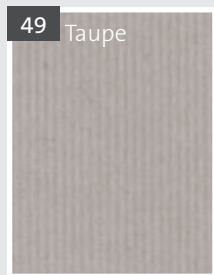
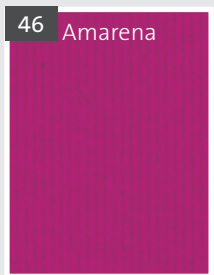
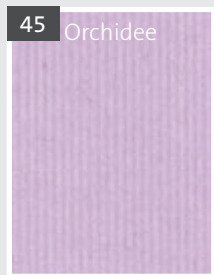
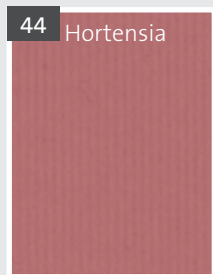
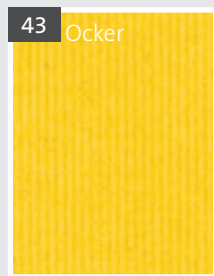
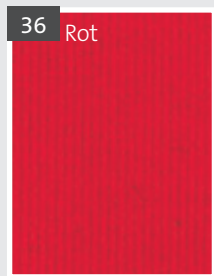
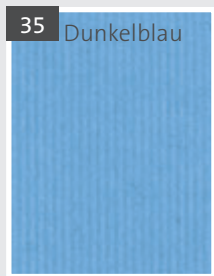
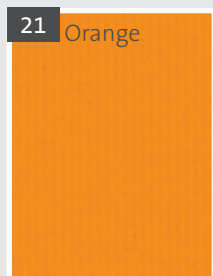
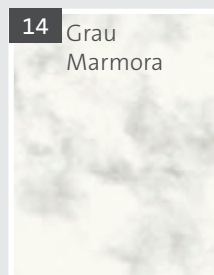
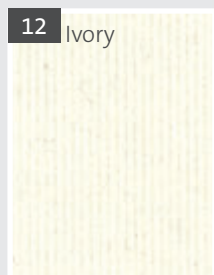
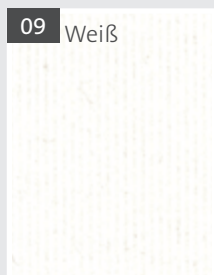
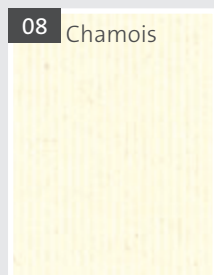
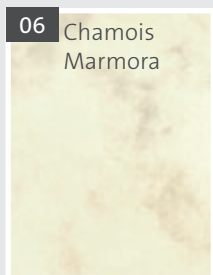

NEU

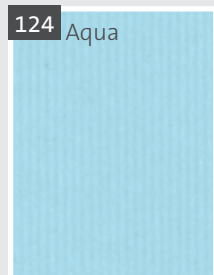
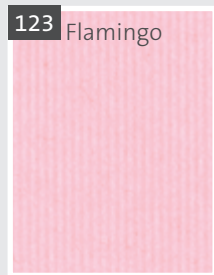
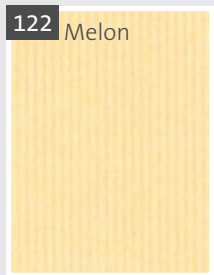
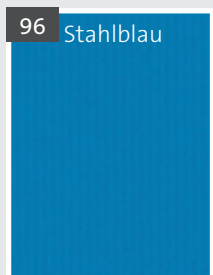



126 Tomate

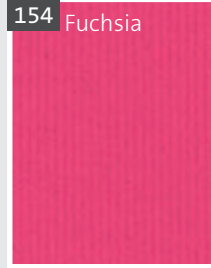

154 Fuchsia

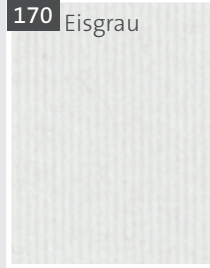

170 Eisgrau

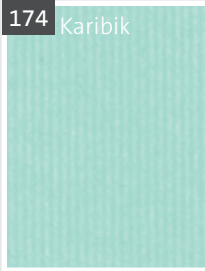

174 Karibik

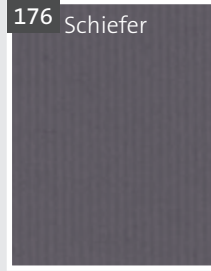

176 Schiefer

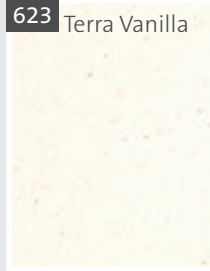

623 Terra Vanilla

VIELE FARBEN AUCH ALS
PACKWARE ERHÄLTlich.
Many colours also available
as paperado pack.
De nombreuses couleurs également
disponibles en pack paperado.

METALLIC · METALLIC · MÉTALLISÉ

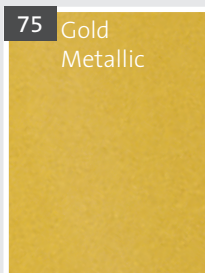

75 Gold
Metallic

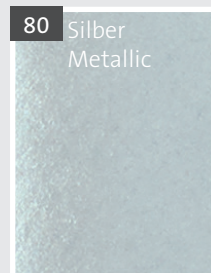

80 Silber
Metallic



302 Marble white
Metallic

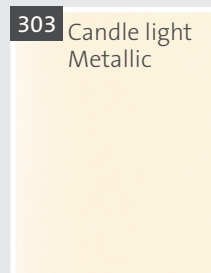

303 Candle light
Metallic



411 Taupe
Metallic

TRANSPARENT · TRANSLUCENT · TRANSPARENT

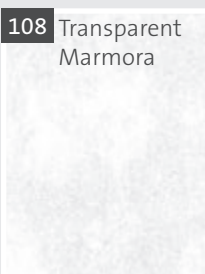

108 Transparent
Marmora



159 Transparent
Weiß



142 Transparent
Hochweiß

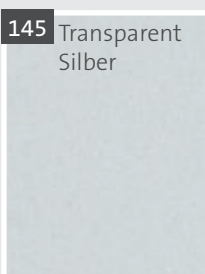

145 Transparent
Silber

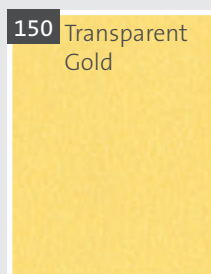

150 Transparent
Gold

Weitere Transparent-Papiere finden Sie auf S. 30.
More transparent papers on page 30.
Plus de papiers transparent aux page 30.

DIE PAPERADO-FORMATE

KARTEN & BLÄTTER · CARDS AND SHEETS · CARTES ET FEUILLES

	Format	Art.Nr. Ref. no. Référence	Maße in mm Dimensions in mm Dimensions en mm	Grammatur Grammage Grammage
	A3	1640 42..	297 x 420	160 g/m ²
	A4	1640 01..	210 x 297	100 g/m ²
	A4	1640 26..	210 x 297	160 g/m ²
	A4	1640 12..	210 x 297	220 g/m ²

GEFALTETE KARTEN · FOLDED CARDS · CARTES DOUBLES

	A5 hd · pf	1640 10..	148 x 210	220 g/m ²
	B6 hd · pf	1640 19..	120 x 169	220 g/m ²
	A6 hd · pf	1640 06..	105 x 148	220 g/m ²
	A7 hd · pf	1640 09..	74 x 105	220 g/m ²
	DIN lang hd · pf	1640 03..	100 x 210	220 g/m ²
	DIN lang ld · lf	1640 04..	210 x 100	220 g/m ²
	Passepartoutkarte oval, dreiteilig · Photocard oval, three panel · Passe-partout ovale, en 3 parties			
	B6	1640 32..	120 x 169	220 g/m ²
	Passepartoutkarte rechteckig, dreiteilig · Photocard rectangular, three panel · Passe-partout rectangulaire, en 3 parties			
	B6	1640 33..	120 x 169	220 g/m ²

PLANOKARTEN · FLAT CARDS, PRE-SCORED · CARTES À PLAT

	A5 hd · pf	1640 71..	148/297 x 210	220 g/m ²
	B6 hd · pf	1640 72..	120/240 x 169	220 g/m ²
	A6 hd · pf	1640 70..	105/210 x 148	220 g/m ²
	DIN lang hd · pf	1640 69..	100/200 x 210	220 g/m ²
	157 x 157 hd/ld · pf/lf	1640 75..	157/314 x 157	220 g/m ²
	B6 ld · lf	1640 76..	169/338 x 120	220 g/m ²
	Tischkarte place card · marque-place	1640 30..	100 x 100	220 g/m ²

GESCHENKKARTEN · GIFT CARDS · CARTES CADEAUX

NEU

	Geschenkkarte DIN lang	1640 66..	210 x 100 mm	220 g/m ²
	Einzelkarte passend für DIN lang	1640 78..	206 x 100 mm	220 g/m ²



hd = hoch doppelt ld = lang doppelt
 pf = portrait folded lf = landscape folded
 hd = double ld = double pliure petit côté

Produkte in Metallic-Qualität weichen in ihrer Grammatur von den angegebenen Werten leicht ab.
 Products in metallic colours have a slightly different weight than shown above.
 Les papiers métalliques ont un grammage légèrement différent de celui mentionné sur la liste.

EINLEGEBLÄTTER · INSERTS · INCARTS

	Format	Art.Nr. Ref. no. Référence	Maße in mm Dimensions in mm Dimensions en mm	Grammatur Grammage Grammage
--	--------	----------------------------------	--	-----------------------------------

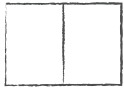

A6 hd plano · pf	1640 83...	206 x 144	100 g/m ²
B6 hd plano · pf	1640 80...	236 x 167	100 g/m ²

erhältlich in · available in · disponible en: 08 | 09 | 12 | 142 | 159 | 164

UMSCHLÄGE MIT SEIDENFUTTER & NASSKLEBUNG
 ENVELOPES WITH TISSUE LINING AND GUMMED FLAPS
 ENVELOPPE DOUBLÉE EN PAPIER SOIE

	Format	Art.Nr. Ref. no. Référence	Maße in mm Dimensions in mm Dimensions en mm	Grammatur Grammage Grammage
--	--------	----------------------------------	--	-----------------------------------

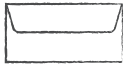

DIN lang	1640 02...	110 x 220	100 g/m ²
----------	------------	-----------	----------------------



164 x 164	1640 40...	164 x 164	100 g/m ²
-----------	------------	-----------	----------------------



C4*	1640 15...	225 x 315	160 g/m ²
C5	1640 11...	157 x 225	100 g/m ²
B6	1640 20...	125 x 178	100 g/m ²
C6	1640 05...	114 x 162	100 g/m ²
C7	1640 07...	81 x 114	100 g/m ²

* ohne Seidenfutter
 without tissue lining
 non doublée

UMSCHLÄGE MIT SEIDENFUTTER & HAFTKLEBUNG
 ENVELOPES WITH TISSUE LINING AND SELFSEAL FLAPS
 ENVELOPPE DOUBLÉE EN PAPIER DE SOIE

	Format	Art.Nr. Ref. no. Référence	Maße in mm Dimensions in mm Dimensions en mm	Grammatur Grammage Grammage
--	--------	----------------------------------	--	-----------------------------------

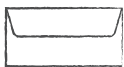

DIN lang	1640 91...	110 x 220	100 g/m ²
----------	------------	-----------	----------------------

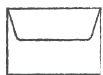

B6	1640 93...	125 x 178	100 g/m ²
C6	1640 92...	114 x 162	100 g/m ²

Umschläge in Metallic- und Transparent-Farben sowie in Kraft werden nicht mit Seidenfutter verarbeitet, um die besondere Material-Eigenschaft hervorzuheben.
 Envelopes in metallic and transparent colours as well as in Kraft are not processed with tissue lining in order to highlight the special material property.
 Les enveloppes dans des couleurs métalliques et transparentes ainsi que dans Kraft ne sont pas doublées pour souligner les propriétés spéciales du matériau.

Bitte ergänzen Sie die Artikelnummer um die jeweilige Farbnummer.
 Please add the respective colour number to the reference number.
 SVP compléter par la référence de l'article et par le code couleur.



NEU

NEU: Einlegekarten, Buttons und Tags in drei attraktiven Aquarelldesigns zum idealen Mix & Match.

NEW: Inlay cards, buttons and tags in three attractive watercolour designs for the ideal mix & match.

NOUVEAU: Cartes à insérer, badges et tags dans trois designs aquarellés attrayants pour un mix & match idéal.

NEU: Papierfarben Rose & Eucalyptus sowie neue Bänder und Garne.

NEW: Rose & Eucalyptus paper colours and new ribbons and yarns.

NOUVEAU: Couleurs de papier Rose & Eucalyptus ainsi que nouveaux rubans et fils.

CREATIVE SHOP EINFACH. BESONDERS. KREATIV.

Besondere Kartenformen, exklusive Papierqualitäten und kreative Accessoires – ein Sortiment, um emotionale Momente unvergesslich zu gestalten.

Special card shapes, exclusive paper qualities and creative accessories – a range to make emotional moments unforgettable.

Des formes de cartes particulières, des qualités de papier exclusives et des accessoires créatifs – un assortiment pour rendre les moments d'émotion inoubliables.



KREATIV-ACCESSOIRES CREATIVE SHOP

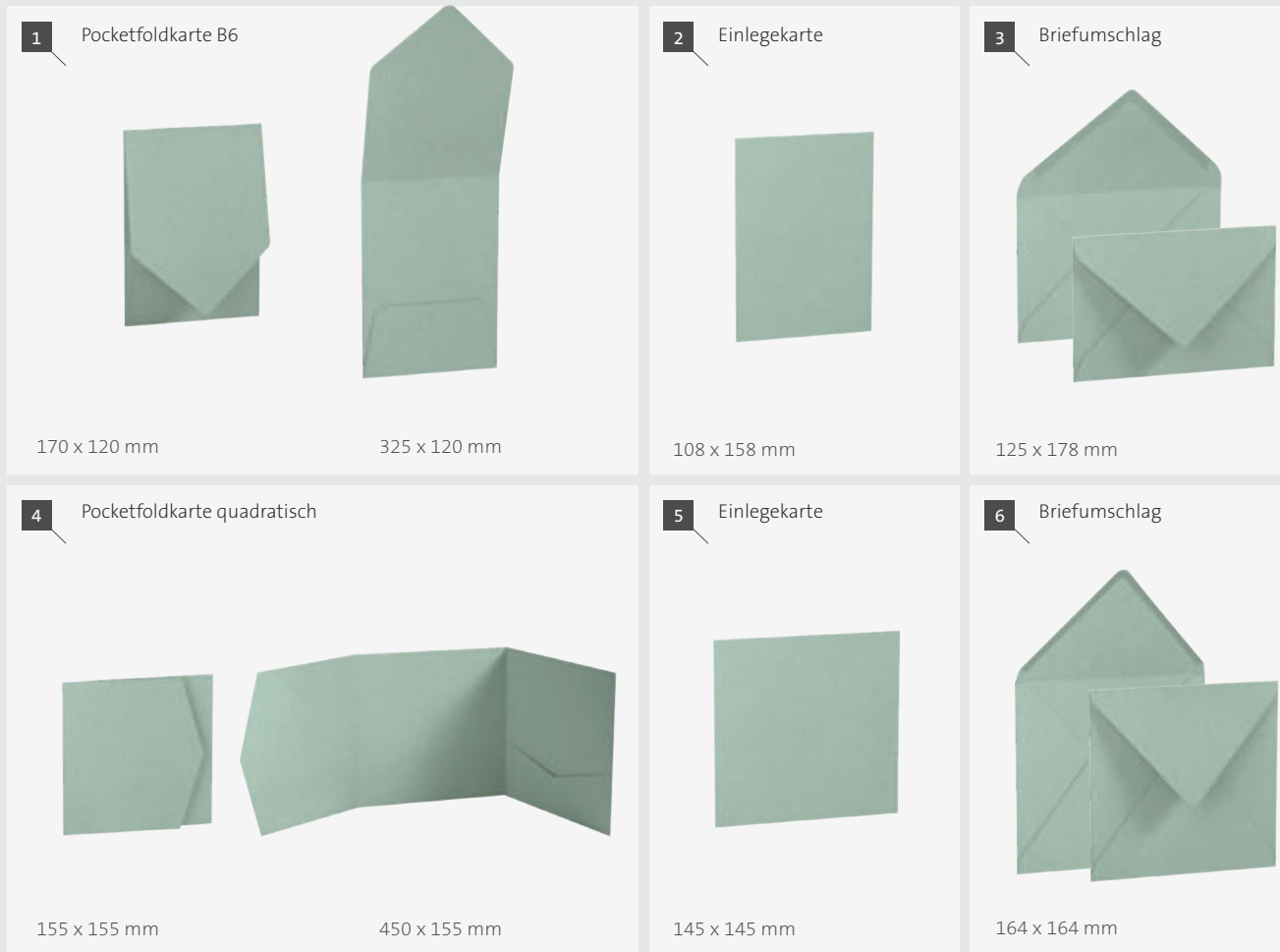

Erhältlich in 8 Farben · available in 8 colours · disponible en 8 couleurs:

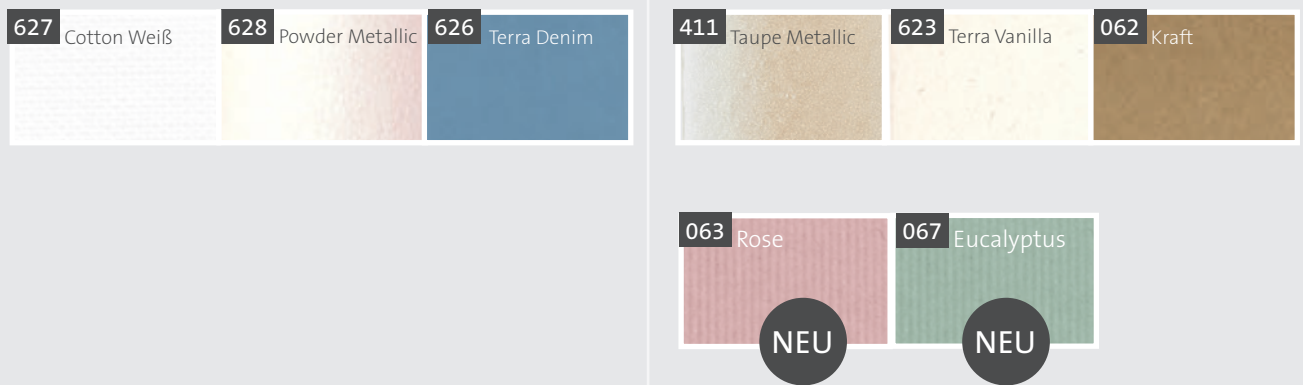

NR.	ART.-NR. · REF NO · RÉFÉRENCE	VE · UNIT · U/VENTE
1	1641 101 ...	25
2	1641 109 ...	50
3	1641 20 ...	50
4	1641 108 ...	25
5	1641 110 ...	50
6	1641 040 ...	25

NR.	ART.-NR. · REF NO · RÉFÉRENCE	VE · UNIT · U/VENTE
1	1641 101 ...	25
2	1641 109 ...	50
3	1640 20 ...	50
4	1641 108 ...	25
5	1641 110 ...	50
6	1640 40 ...	25

Einlegekarte
für Pocketfoldkarte B6
108 x 158 mm

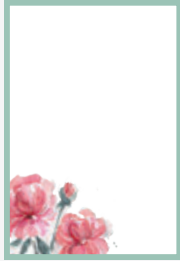

1641 109 400 / VE 50

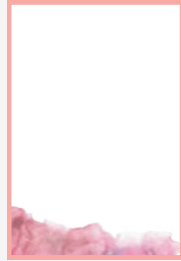

1641 109 500 / VE 50



1641 109 600 / VE 50



Einlegekarte
für Pocketfoldkarte
quadratisch
145 x 145 mm



1641 110 400 / VE 50



1641 110 500 / VE 50



1641 110 600 / VE 50



Einlegekarte
für Pocketfoldkarte B6
108 x 158 mm,
COTTON 240 g/m²
Heißfolie Gold



1641 109 100 / VE 50



1641 109 200 / VE 50



1641 109 300 / VE 50



Einlegekarte
für Pocketfoldkarte
quadratisch
145 x 145 mm,
COTTON 240 g/m²
Heißfolie Gold



1641 110 100 / VE 50



1641 110 200 / VE 50



1641 110 300 / VE 50



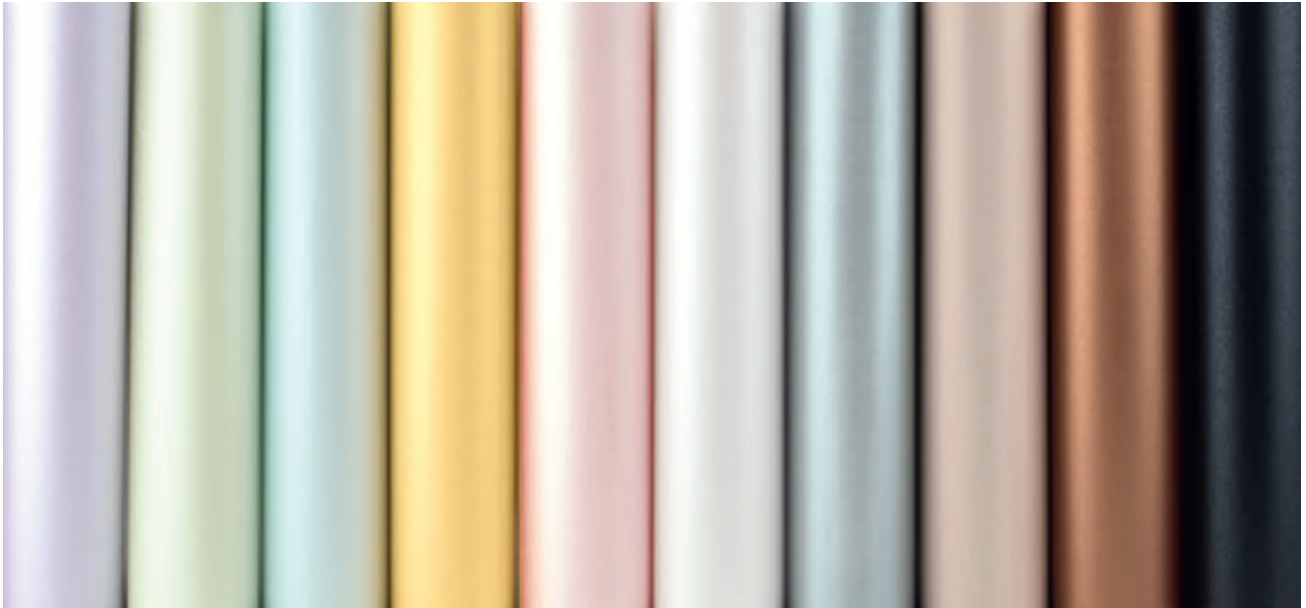

FINE PAPER

AUSSERGEWÖHNLICHE PAPIERE

Das Sortiment Fine Paper besteht aus einzigartigen Edel-Papieren, die faszinieren und begeistern: Metallic-Papiere, Transparentpapiere, Edel- und Naturpapiere, Japan-Papiere.

Diese hochwertige Auswahl an besonderen Papieren ist eine ideale Ergänzung zum Paperado-Sortiment. Die außergewöhnlichen Papiere der Fine Paper-Linie eignen sich bestens zum kreativen Gestalten und auch für besondere Anlasskorrespondenz. Sie begeistern durch Haptik, Struktur und optische Effekte. Viele der Papiere lassen sich trotz ihrer besonderen Struktur gut bedrucken. Unser Vertrieb berät Sie gerne!

Fine Paper is a range of extraordinarily elegant papers. Fine Paper products are a high quality addition to the laid Paperado papers. They range from e.g. premium transparent papers through natural and premium papers with textured surfaces to metallic papers with a silky sheen. There are also unique papers made using traditional Japanese paper making techniques. Our sales team will be happy to advise you!

Fine Paper est une gamme de papiers exceptionnels. Fine Paper est une gamme de produits de haute qualité complémentaire à Paperado. Fine Paper ce sont des papiers transparents, haut de gamme, ainsi que des papiers, métalliques, brillants, naturels avec des surfaces et des structures spéciales. De plus, des papiers de production issus d'une vieille tradition japonaise font partie de la gamme Fine Paper. Notre équipe sera heureuse de vous aider!

METALLIC-PAPIER · METALLIC PAPER · PAPIER MÉTALLISÉ

Erhältlich in den Formaten · Available in the formats · Disponible dans les formats:



DIN A4

1645 01 ...

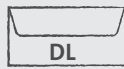

DL

1645 02 ...

Bitte ergänzen Sie die gewünschte Farbnummer · Please add colour code · Ajoutez code couleur:

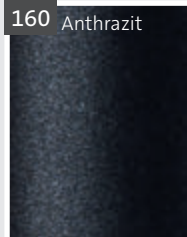

160 Anthrazit

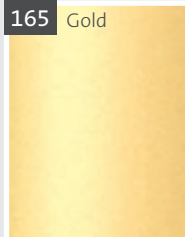

165 Gold

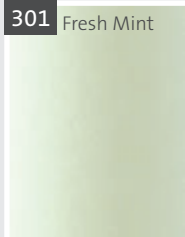

301 Fresh Mint

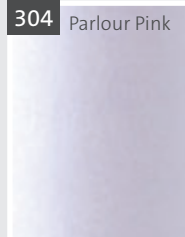

304 Parlour Pink

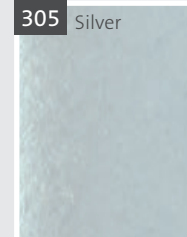

305 Silver



306 Kupfer

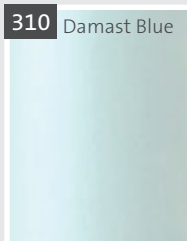

310 Damast Blue

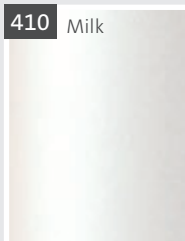

410 Milk

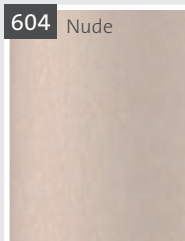

604 Nude

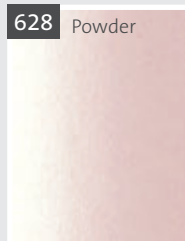

628 Powder

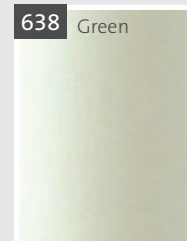

638 Green



639 Rose

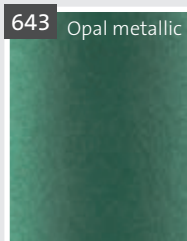

643 Opal metallic

Weitere Metallic-Papiere in unserem Paperado-Sortiment auf S. 19:
More metallic papers in our Paperado range on page 19:
Plus de papiers métalliques dans notre gamme Paperado aux page 19:

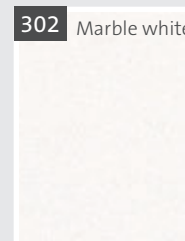

302 Marble white

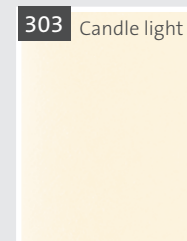

303 Candle light



411 Taupe Metallic

NATURPAPIERE · NATURAL PAPERS · PAPIERS NATURELS

Erhältlich in den Formaten · Available in the formats · Disponible dans les formats:



DIN A4

1645 01 ...



DL

1645 02 ...

Bitte ergänzen Sie die gewünschte Farbnummer · Please add colour code · Ajoutez code couleur:

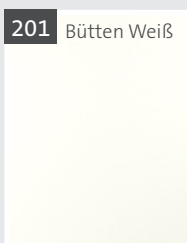

201 Bütten Weiß

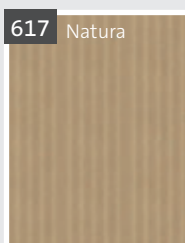

617 Natura

BUNTE PAPIERWELT FINE PAPER

NATURPAPIERE · NATURAL PAPERS · PAPIERS NATURELS

Erhältlich in den Formaten · Available in the formats · Disponible dans les formats:



1645 01 ... Bitte ergänzen Sie die gewünschte Farbnummer · Please add colour code · Ajoutez code couleur:

JAPAN-PAPIERE · JAPANESE PAPER · PAPIER JAPONAIS

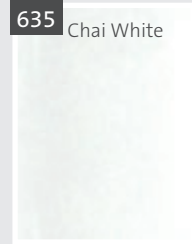
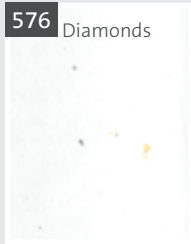

BLUMEN-PAPIERE · FLOWER PAPERS · PAPIERS DE FLEUR

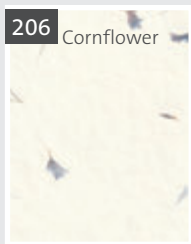
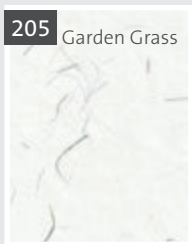

TERRA NATURPAPIERE · TERRA NATURAL PAPERS · TERRA PAPIERS NATURELS

Erhältlich in den Formaten · Available in the formats · Disponible dans les formats:



1645 01 ...



1645 91 ...

Bitte ergänzen Sie die gewünschte Farbnummer · Please add colour code · Ajoutez code couleur:

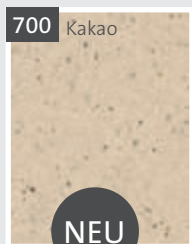
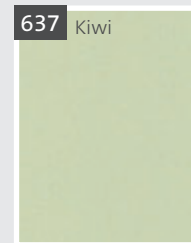
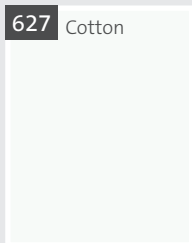
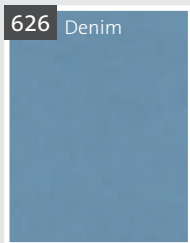
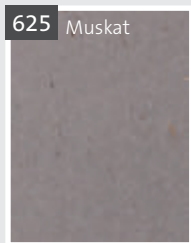
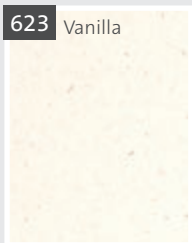

NEU

NEU

Erhältlich auch als Packware in ausgewählten Formaten (siehe S. 29).

Also available as packaged goods in selected formats (see p. 29).

Également disponible sous forme de produits emballés dans une sélection de formats (voir p. 29).

TERRA PACKWARE EINZIGARTIGE NATURPAPIERE



DIN A4 · 5 Blatt · Sheets · Feuilles
120 g/m²
1144 001 ... | VE 10

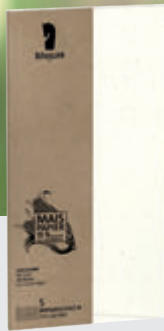

DL · 5 Umschläge · Envelopes · Enveloppes
120 g/m²
1144 002 ... | VE 10

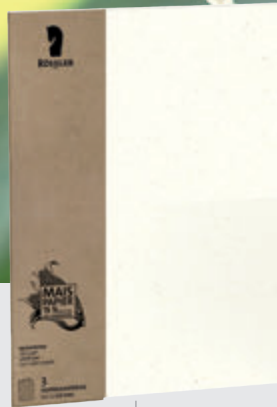

B6 hd plano · 3 Karten · Cards · Cartes
240 g/m²
1144 072 ... | VE 10



A7 · 3 Karten hd · Cards · Cartes
240 g/m²
1144 009 ... | VE 10



B6 · 3 Umschläge · Envelopes · Enveloppes
120 g/m²
1144 020 ... | VE 10



C7 · 3 Umschläge · Envelopes · Enveloppes
120 g/m²
1144 007 ... | VE 10

701

NEU

MAIS

Mit 15% Resten aus der Mais-Verarbeitung
40% Recyclinganteil

700

NEU

KAKAO

Mit 15% Resten aus der Kakao-Verarbeitung
40% Recyclinganteil

637

KIWI

Mit 15% Resten aus der Kiwi-Verarbeitung
40% Recyclinganteil

626

DENIM

Mit 10% Baumwolle
30% Recyclinganteil

640

GRAPE

Mit 15% Resten aus der Trauben-Herstellung
40% Recyclinganteil

641

FLANELL

Mit 15% Wollresten
40% Recyclinganteil

627

COTTON

Exklusive Hammerschlagstruktur

625

MUSKAT

Mit 10% Baumwollanteil
30% Recyclinganteil

BUNTE PAPIERWELT FINE PAPER

TRANSPARENTPAPIERE · TRANSLUCENT PAPER · PAPIER TRANSPARENT

Erhältlich in den Formaten · Available in the formats · Disponible dans les formats:



DIN A4

1640 01 ...



1645 01 ...*



DL

1640 02 ...

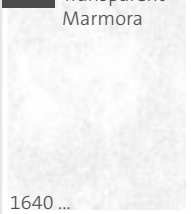
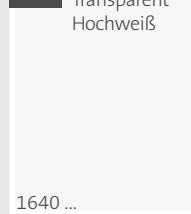
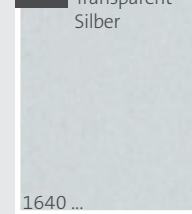
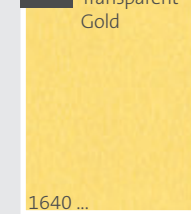
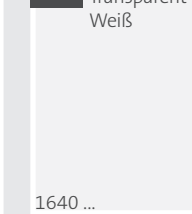
Bitte ergänzen Sie die gewünschte Farbnummer · Please add colour code · Ajoutez code couleur:

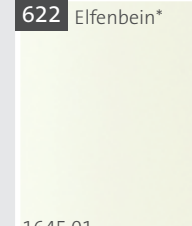
<p>108 Transparent Marmora</p>  <p>1640 ...</p>	<p>142 Transparent Hochweiß</p>  <p>1640 ...</p>	<p>145 Transparent Silber</p>  <p>1640 ...</p>	<p>150 Transparent Gold</p>  <p>1640 ...</p>	<p>159 Transparent Weiß</p>  <p>1640 ...</p>
<p>164 Sternenhimmel*</p>  <p>1645 01 ...</p>	<p>313 Perlmutter*</p>  <p>1645 01 ...</p>	<p>622 Elfenbein*</p>  <p>1645 01 ...</p>	<p>* nur in DIN A4 erhältlich only available in DIN A4 uniquement disponible en A4</p>	

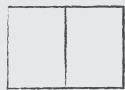

Karte · Card · Carte

A6 hd plano 1640 70.. 105/210 x 148 mm

B6 hd plano 1640 72.. 120/240 x 169 mm



157 x 157 mm 1640 75.. 157/314 x 157 mm



C6

1640 05... 114 x 162 mm

B6

1640 20... 125 x 178 mm

C5

1640 11... 157 x 225 mm



164 x 164 mm 1640 40... 164 x 164 mm



159 Transparent Weiß

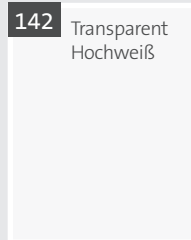

142 Transparent Hochweiß

EINLEGEBLÄTTER · INSERT SHEETS · INSENT FEUILLES



für · for · pour

A6 hd plano 1640 83.. 206 x 144 mm

B6 hd plano 1640 80.. 236 x 167 mm



164 Transparent Sternenhimmel

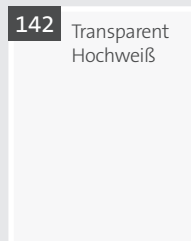

142 Transparent Hochweiß

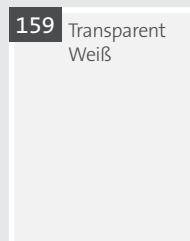

159 Transparent Weiß

BÜTTENPAPIER
VON HAND GERISSEN
hand-torn
déchiré à la main

RÖSSLER BÜTTEN PACKWARE BUNTE PAPIERWELT



1104 001 201 / VE 10



4 014970 189821

5 DIN A4 Blätter · sheets · feuilles

5 DL Briefumschläge · envelopes · enveloppes
mit Seidenfutter · tissue lining · doublées en papier de soie



1104 002 201 / VE 5



4 014970 189838

5 / DL Einzelkarten · flat cards · cartes simples



1104 127 201 / VE 5



4 014970 368400

5 / DIN A6 Doppelkarten · folded cards ·
cartes doubles



1104 006 201 / VE 5



4 014970 368387

5 / C6 Briefumschläge · envelopes · enveloppes
mit Seidenfutter · tissue lining · doublées en
papier de soie



1104 005 201 / VE 5



4 014970 189845

5 / B6 Doppelkarten · folded cards · cartes doubles



1104 019 201 / VE 5



4 014970 368394

5 / B6 Briefumschläge · envelopes · enveloppes
mit Seidenfutter · tissue lining · doublées en papier de soie



1104 020 201 / VE 5



4 014970 189869

5 / DIN A5 hd plano Doppelkarten · folded cards · cartes doubles



1104 071 201 / VE 5



4 014970 189890

5 / C5 Briefumschläge · envelopes · enveloppes
mit Seidenfutter · tissue lining · doublées en papier de soie



1104 011 201 / VE 5



4 014970 189852

BUNTE PAPIERWELT DESIGNPACKS

Schreibsets

Writing sets

Sets de correspondance

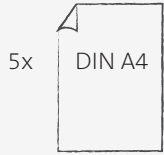

Hochwertiges
120 g/m² Naturpapier



Hochwertiges
100 g/m² Papier

NEU

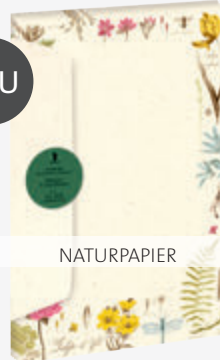

NATURPAPIER

1134 1688 800 / VE 5
4 014970 437663

NEU

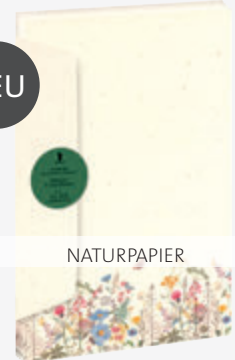

NATURPAPIER

1134 1960 800 / VE 5
4 014970 429392

NEU

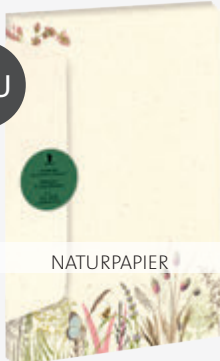

NATURPAPIER

1134 1689 800 / VE 5
4 014970 437670

NEU

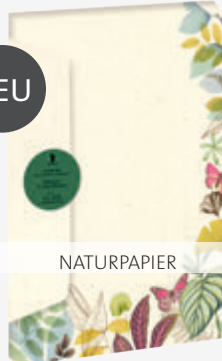

NATURPAPIER

1134 1690 800 / VE 5
4 014970 437687

NEU

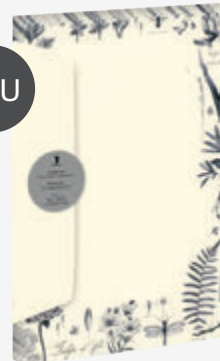

1134 1901 800 / VE 5
4 014970 409158

NEU

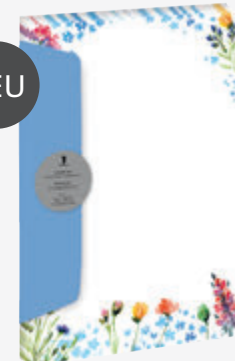

1134 1693 800 / VE 5
4 014970 437717

NEU



1134 1692 800 / VE 5
4 014970 437700

NEU

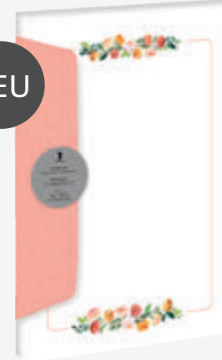

1134 1691 800 / VE 5
4 014970 437694



1134 1367 800 / VE 5
4 014970 216541



1134 1687 800 / VE 5
4 014970 384257



1134 1290 800 / VE 5
4 014970 172052



1134 1901 800 / VE 5
4 014970 409158



1134 1904 800 / VE 5
4 014970 409561



1134 1903 800 / VE 5
4 014970 409165

DESIGNPACKS BUNTE PAPIERWELT

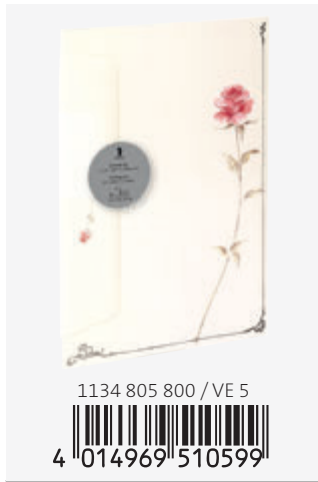

Designpacks
Hochwertiges
100 g/m² Papier

Premium paper 100 g/m²
Papier premium 100 g/m²

DIN A4

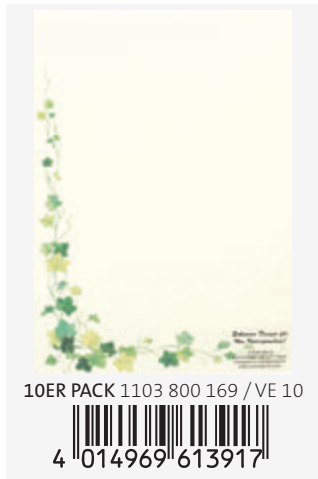
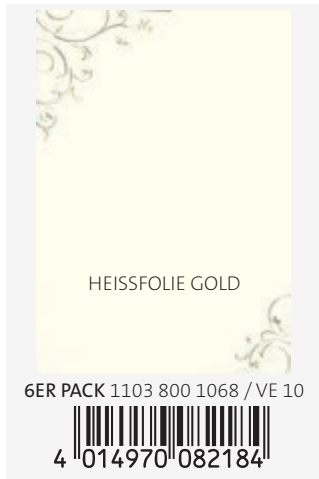
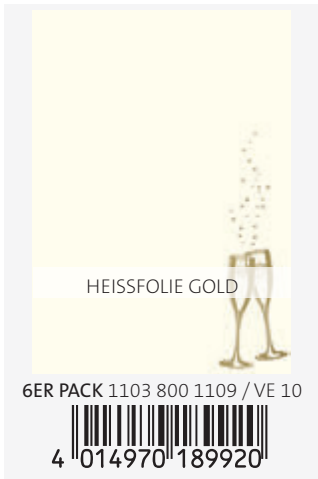
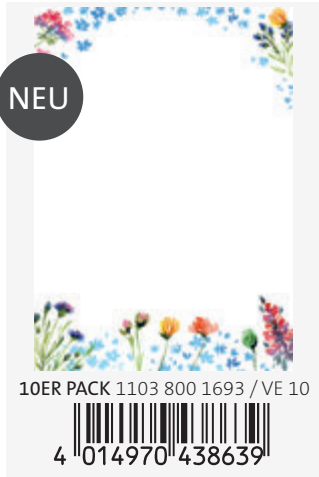

DESIGNBLÄTTER

PRE-PRINTED PAPER

FEUILLES DESIGN

Unsere Designblätter gibt es in vier Varianten:

Our design sheets are available in four variants:

Nos feuilles de conception sont disponibles en quatre variantes:

A – Bedruckte (Offset-Druck) Blätter:

Geeignet für Kopierer, Laser- und Inkjetdrucker

Printed Sheets: Suitable for copiers, laser and inkjet printers

Feuilles imprimées: Copiable, Laser compatible, Inkjet compatible

B – HF-Heißfolienblätter:

Geeignet für Kopierer, Laser- und Inkjetdrucker

Bitte achten Sie auf die Temperaturentwicklung des Gerätes.

Hotfoil sheets: Suitable for copy, laser, inkjet. Please pay attention to the temperature evolution of your device.

Papier avec impression métallique: impression laser et jet d'encre. Faire attention à la température de votre imprimante afin d'éviter les dommages.

C – TR-Transparentblätter:

Einseitig bedruckt. Bedingt für Inkjet- bzw. Laserdrucker

geeignet. Bitte achten Sie auf die Temperaturentwicklung des Gerätes.

Einzelblatt-Einzug empfohlen. Druckfarbe benötigt auf Transparentpapier extra Trocknungszeit.

Transparent paper: Printed on one side. Conditionally suitable for inkjet or laser printers.

Please pay attention to the temperature development of your device.

Single sheet feed recommended. Printing colour needs extra drying time on transparent paper.

Papier transparent: 1 face imprimable, laser et jet d'encre.

Faire attention à la température de votre imprimante afin d'éviter les dommages.

Recommandations: imprimer feuille par feuille et laisser sécher lentement

D – KR-Kreativpapier:

Bedrucken über die manuelle Papierzufuhr.

Bitte prüfen Sie die technischen Voraussetzungen Ihres Druckers.

Creative papers: Use manual feed only.

Please check the technical requirements of your printer.

Papiers créatifs: Uniquement en alimentation manuelle.

SVP vérifier les impératifs techniques de votre imprimante.



Designblätter
Pre-Printed paper
Feuilles Design

DIN A4
VE, unit, u/vente: 50
HF = Heißfolienprägung
hot foil · impression

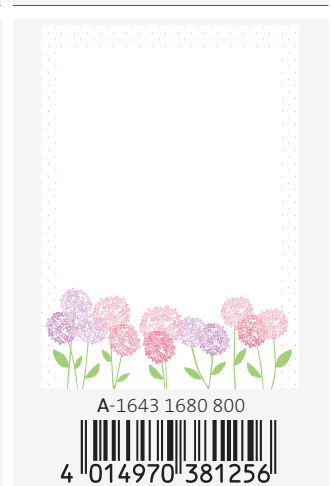
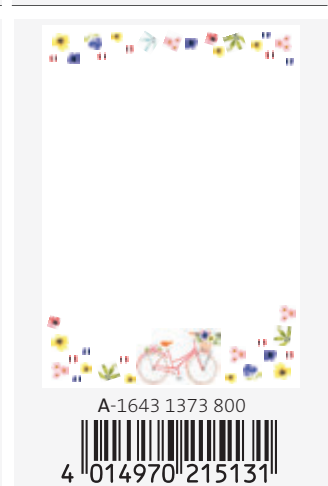
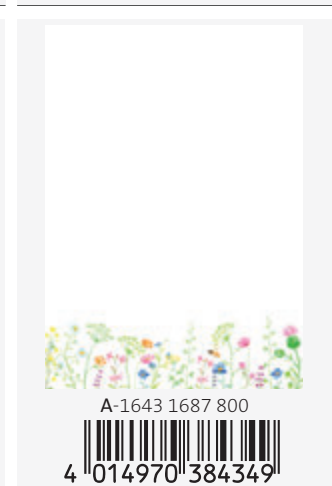
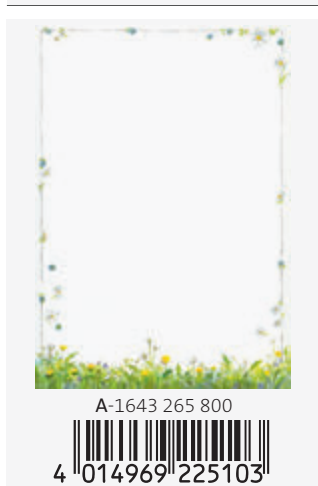
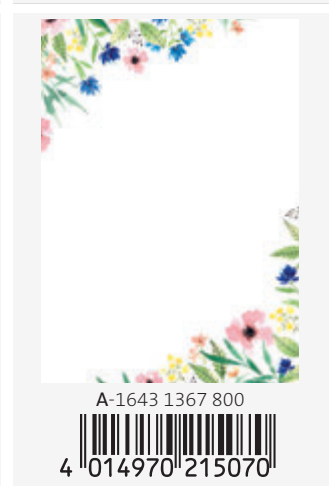
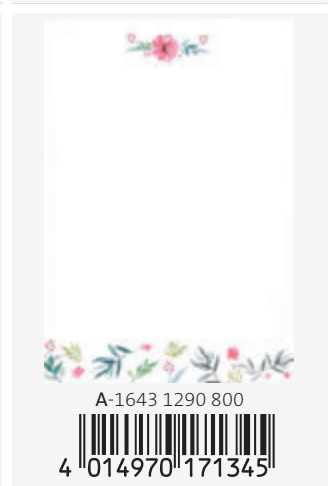
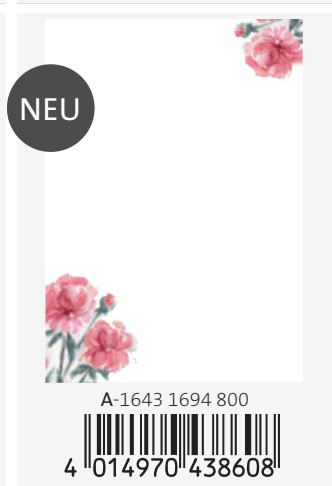
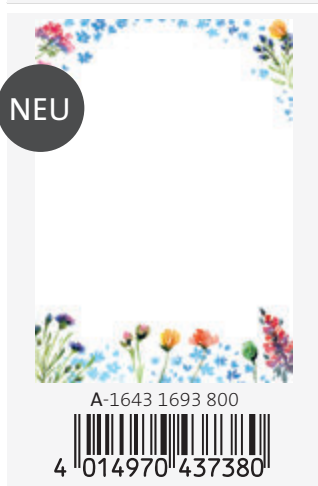
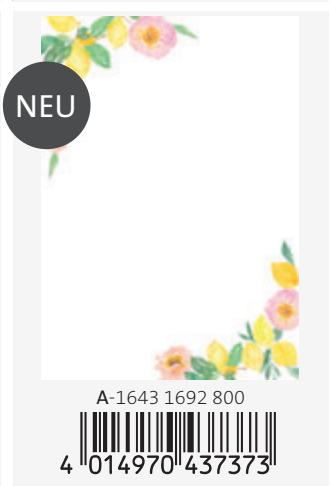
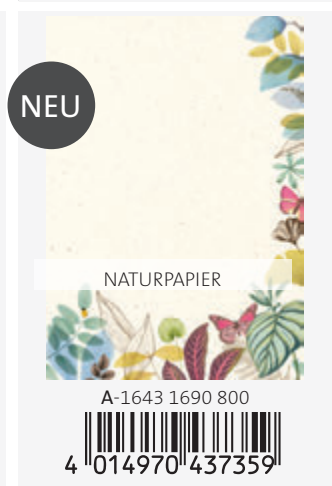
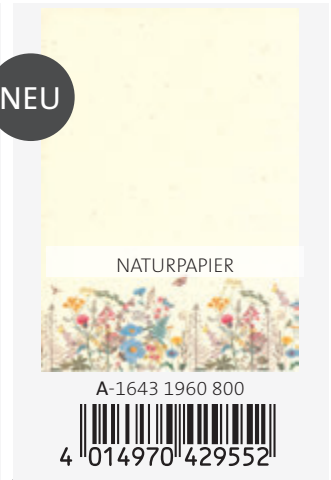

BUNTE PAPIERWELT DESIGNBLÄTTER

PRE-PRINTED PAPER · FEUILLES DESIGN

Designblätter

Pre-Printed paper
Feuilles Design

DIN A4

VE, unit, u/vente: 50

HF = Heißfolienprägung
hot foil · impression



A-1643 524 800



4 014969 247679



A-1643 805 800



4 014969 477199



A-1643 169 800



4 014969 202821



A-1643 1903 800



4 014970 409196



A-1643 974 800



4 014969 557754



A-1643 1810 800



4 014970 381300

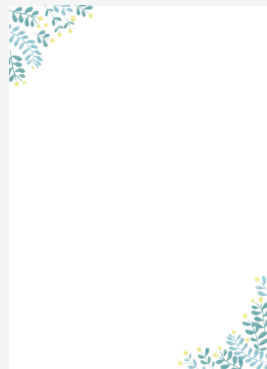

A-1643 1904 800



4 014970 409417



A-1643 1941 800



4 014970 423529



A-1643 1944 800



4 014970 423536

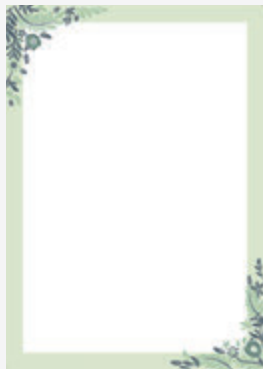

A-1643 1901 800



4 014970 409202





BUNTE PAPIERWELT DESIGNBLÄTTER
 PRE-PRINTED PAPER · FEUILLES DESIGN

Designblätter

Pre-Printed paper
 Feuilles Design

DIN A4

VE, unit, u/vente: 50

HF = Heißfolienprägung
 hot foil · impression

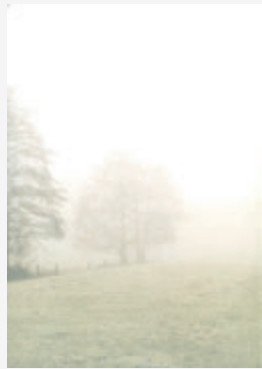

A-1643 032 800



4 014969 251423

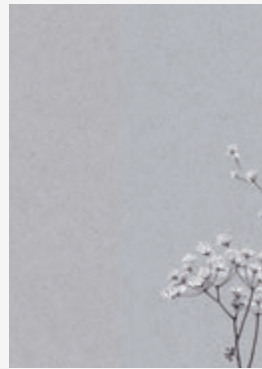

A-1643 1678 800



4 014970 369407



BEIDSEITIG BEDRUCKT

A-1643 390 800



4 014969 558393



170 g/m2

A-1643 270 800



4 014969 225196



250 g/m2, DIN A3

A-1643 270 808 / DIN A3



4 014969 225202



170 g/m2, DIN A4

A-1643 284 800 / DIN A4



4 014969 229156



170 g/m2

A-1643 289 800



4 014969 235713



KREATIVBLÄTTER BUNTE PAPIERWELT
CREATIVE PAPERS · PAPIERS CRÉATIFS

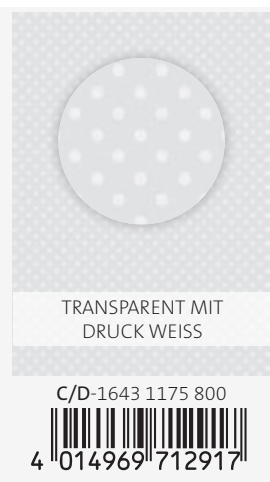

BUNTE PAPIERWELT TWIN PAPERS

HEISSFOLIE GOLD

1642 2000 800 / VE 25

4 014970 132582

HEISSFOLIE GOLD

1642 2003 800 / VE 25

4 014970 132612

HEISSFOLIE GOLD

1642 2004 800 / VE 25

4 014970 132629

HEISSFOLIE GOLD

1642 2007 800 / VE 25

4 014970 132650

HEISSFOLIE GOLD

1642 2009 800 / VE 25

4 014970 132674

HEISSFOLIE GOLD

1642 2013 800 / VE 25

4 014970 132711

HEISSFOLIE GOLD

1642 2020 800 / VE 25

4 014970 168536

HEISSFOLIE GOLD

1642 2021 800 / VE 25

4 014970 168543

TWIN PAPERS BUNTE PAPIERWELT



1642 2023 800 / VE 25



4 014970 168567

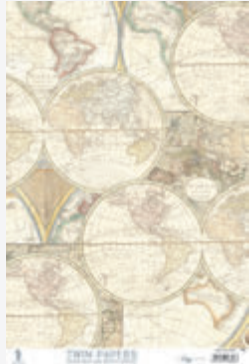

HEISSFOLIE GOLD

1642 2024 800 / VE 25



4 014970 168574



HEISSFOLIE GOLD

1642 2026 800 / VE 25



4 014970 168598

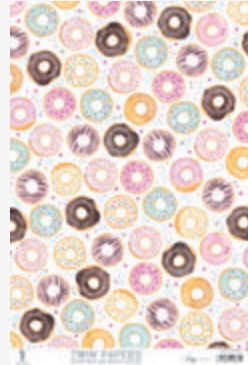

1642 2030 800 / VE 25



4 014970 216725



HEISSFOLIE GOLD



1642 2031 800 / VE 25



4 014970 244940



HEISSFOLIE GOLD

TWIN PAPERS
PRINTED ON BOTH SIDES



1642 2032 800 / VE 25



4 014970 246234



HEISSFOLIE GOLD

TWIN PAPERS
PRINTED ON BOTH SIDES



BUNTE PAPIERWELT GLITTER PAPERS



LIGHT GREEN

1649 1000 800 / VE 25



4 014970 134128

WARM PINK

1649 1001 800 / VE 25



4 014970 134135

LIGHT COPPER

1649 1002 800 / VE 25



4 014970 134142

SHINY WHITE

1649 1003 800 / VE 25



4 014970 134159

SILVER

1649 1004 800 / VE 25



4 014970 134166

PLATIN GOLD

1649 1005 800 / VE 25



4 014970 134173

RED

1649 1006 800 / VE 25



4 014970 134111

GOLD

1649 1007 800 / VE 25



4 014970 166396

OCEAN

1649 1008 800 / VE 25



4 014970 234279





KREATIV BEZAUBERND ACCESSOIRES

Die liebevoll gestalteten Kreativ-Produkte von Rössler laden ein zu phantasievollen Kreationen, die Spaß machen und Freude schenken. Von Stickern über Stempel bis hin zu Textilbändern und Garnen führen wir ein vielfältiges Kreativsortiment, das inspiriert.

The lovingly designed creative products from Rössler invite you to make imaginative creations that are both fun and pleasing.

Les produits créatifs de Rössler, conçus avec amour, invitent à des créations pleines de fantaisie qui amusent et font plaisir.





NEU

NEU: Einlegekarten, Buttons und Tags in drei attraktiven Aquarelldesigns zum idealen Mix & Match.

NEU: Papierfarben Rose & Eucalyptus sowie neue Bänder und Garne.

NEW: Inlay cards, buttons and tags in three attractive watercolour designs for the ideal mix & match.

NEW: Rose & Eucalyptus paper colours and new ribbons and yarns.

NOUVEAU: Cartes à insérer, badges et tags dans trois designs aquarellés attrayants pour un mix & match idéal.

NOUVEAU: Couleurs de papier Rose & Eucalyptus ainsi que nouveaux rubans et fils.

CREATIVE SHOP EINFACH. BESONDERS. KREATIV.

Besondere Kartenformen, exklusive Papierqualitäten und kreative Accessoires – ein Sortiment, um emotionale Momente unvergesslich zu gestalten.

Special card shapes, exclusive paper qualities and creative accessories – a range to make emotional moments unforgettable.

Des formes de cartes particulières, des qualités de papier exclusives et des accessoires créatifs – un assortiment pour rendre les moments d'émotion inoubliables.



KREATIV-ACCESSOIRES CREATIVE SHOP

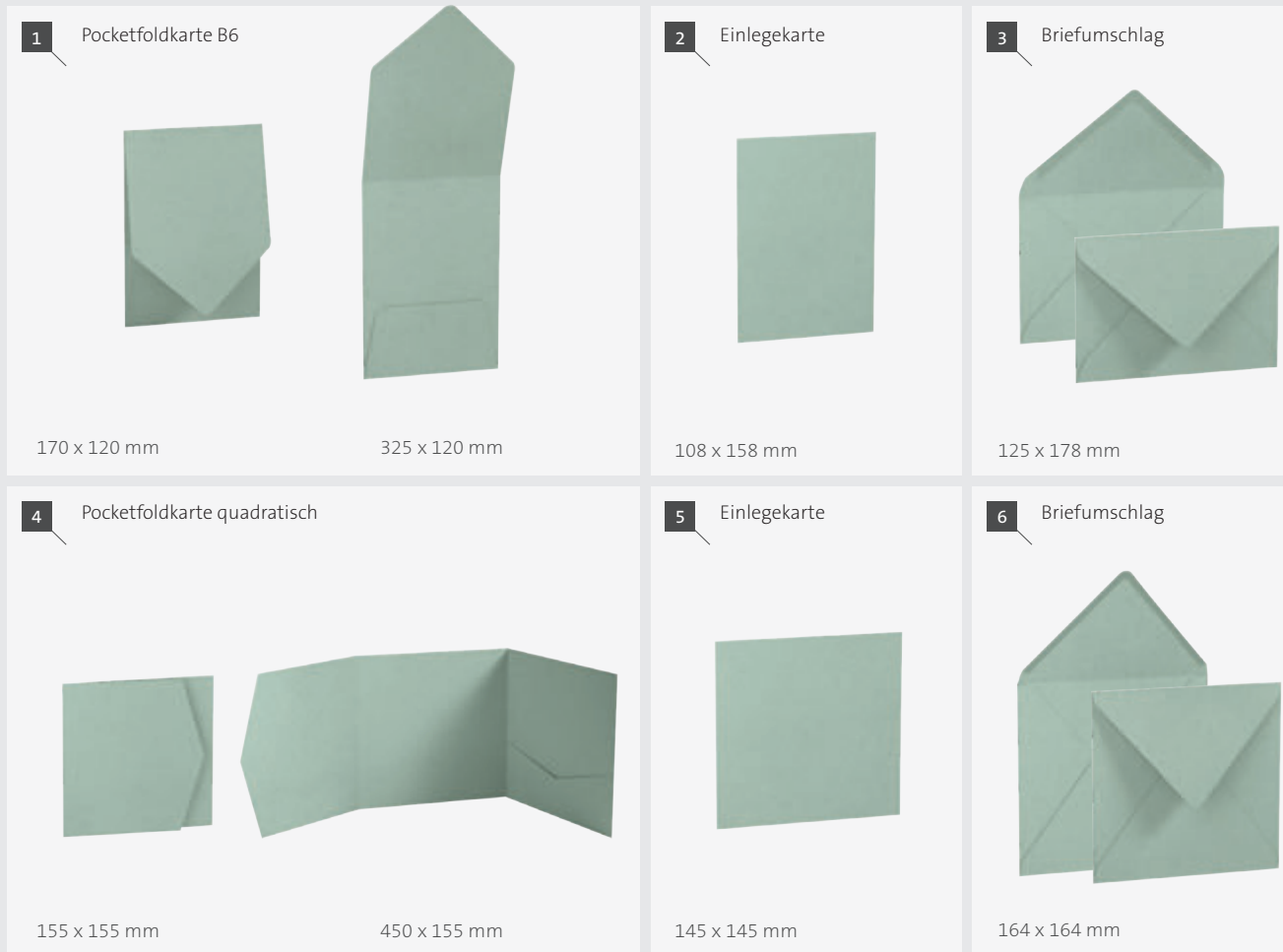

Erhältlich in 8 Farben · available in 8 colours · disponible en 8 couleurs:

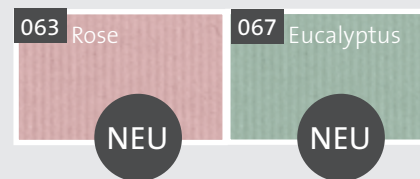
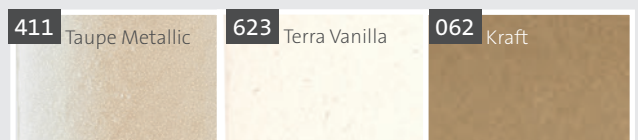
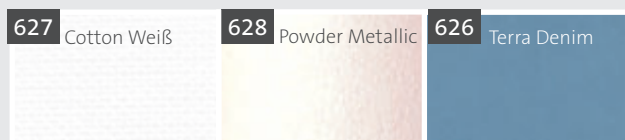

NR.	ART.-NR. · REF NO · RÉFÉRENCE	VE · UNIT · U/VENTE
1	1641 101 ...	25
2	1641 109 ...	50
3	1641 20 ...	50
4	1641 108 ...	25
5	1641 110 ...	50
6	1641 040 ...	25

NR.	ART.-NR. · REF NO · RÉFÉRENCE	VE · UNIT · U/VENTE
1	1641 101 ...	25
2	1641 109 ...	50
3	1640 20 ...	50
4	1641 108 ...	25
5	1641 110 ...	50
6	1640 40 ...	25

Einlegekarte
für Pocketfoldkarte B6
108 x 158 mm

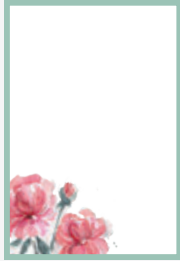

1641 109 400 / VE 50

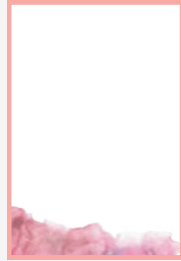

1641 109 500 / VE 50



1641 109 600 / VE 50



Einlegekarte
für Pocketfoldkarte
quadratisch
145 x 145 mm



1641 110 400 / VE 50



1641 110 500 / VE 50



1641 110 600 / VE 50



Einlegekarte
für Pocketfoldkarte B6
108 x 158 mm,
COTTON 240 g/m²
Heißfolie Gold



1641 109 100 / VE 50



1641 109 200 / VE 50



1641 109 300 / VE 50



Einlegekarte
für Pocketfoldkarte
quadratisch
145 x 145 mm,
COTTON 240 g/m²
Heißfolie Gold



1641 110 100 / VE 50



1641 110 200 / VE 50



1641 110 300 / VE 50



KREATIV-ACCESSOIRES TAGS & BUTTONS

4 Tags mit 1 m Kordel
Heißfolie Gold



Rose
1403 10500 034 / VE 8

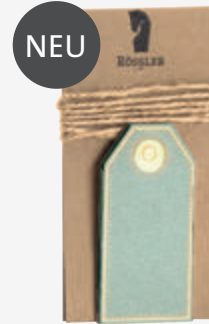

Eucalyptus
1403 10500 035 / VE 8



4 Tags mit 1 m Kordel
4,8 x 8 cm

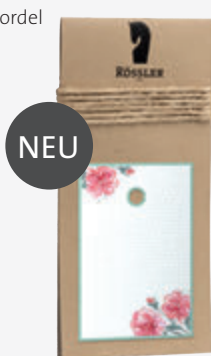

1403 10500 036 / VE 8



1403 10500 037 / VE 8

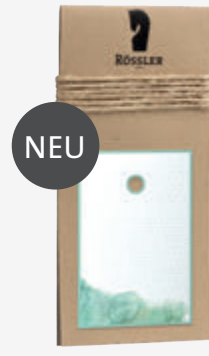

1403 10500 038 / VE 8



4 Tags mit 1 m Kordel
Heißfolie Gold



Terra Vanilla
1403 10500 025 / VE 8



Kraft
1403 10500 026 / VE 8



Powder Metallic
1403 10500 027 / VE 8



6 Kreativ Labels
5,3 x 3,2 cm
Heißfolie Gold



1406 10500 001 / VE 8



1406 10500 002 / VE 8



1406 10500 003 / VE 8



TAGS & BUTTONS KREATIV-ACCESSOIRES

4 x 2 Kreativbuttons

NEU

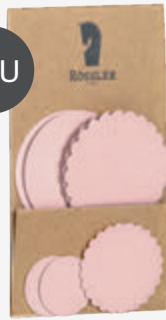

Rose
1407 10500 063 / VE 8



NEU

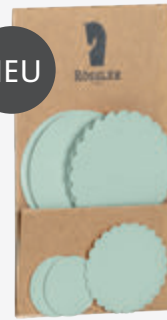

Eucalyptus
1407 10500 067 / VE 8



2 x 4 Kreativbuttons

NEU



1407 10500 111 / VE 8



NEU



1407 10500 222 / VE 8



NEU



1407 10500 333 / VE 8



4 x 2 Kreativbuttons



Glitter
1407 10500 058 / VE 8



Kraft
1407 10500 062 / VE 8



Taupe Metallic
1407 10500 411 / VE 8



Terra Vanilla
1407 10500 623 / VE 8



Terra Denim
1407 10500 626 / VE 8



Cotton
1407 10500 627 / VE 8



Powder Metallic
1407 10500 628 / VE 8



5 x 5 x 2 mm, Klebekissen



1407 15201 000 / VE 6



KREATIV-ACCESSOIRES GARNE

TWINES · FILS

Metallgarn
25 m / 1,5 mm



Gold
8008 10500 014 / VE 3



Silber
8008 10500 080 / VE 3



Roségold
8008 10500 013 / VE 3



8008 10500 999 / VE 1



3 x 4 sortiert · assorted · assorties

Baumwollgarn mit Metallfaden · cotton yarn with metallic thread · fil de coton avec fil métallique
20 m / 2 mm



Weiß / Silber
8005 10500 000 / VE 3



Rosé / Gold
8005 10500 012 / VE 3



Eucalyptus / Gold
8005 10500 060 / VE 3



Ivory / Gold
8005 10500 070 / VE 3



Taupe / Silber
8005 10500 080 / VE 3



Grau / Gold
8005 10500 083 / VE 3



6 x 3 sortiert · assorted · assorties



Flieder / Gold
8005 10500 038 / VE 3



Lila / Gold
8005 10500 092 / VE 3



8005 10500 888 / VE 1



Baumwollgarn mit goldenem Faden · cotton yarn with golden thread · fil de coton avec fil d'or
50 m / 2 mm



Grün / Gold
8006 10500 097 / VE 3



4 014970 226861

Rot / Gold
8006 10500 126 / VE 3



4 014970 314957

Schwarz / Gold
8006 10500 070 / VE 3



4 014970 314971

Rosé / Gold
8006 10500 013 / VE 3



4 014970 381607

Baumwollgarn mit goldenem Faden · Cotton yarn with golden thread · Fil de coton avec fil d'or
50 m / 2 mm



Eucalyptus / Gold
8006 10500 060 / VE 3



4 014970 314988

Crème / Gold
8006 10500 002 / VE 3



4 014970 314964

Lila / Gold
8006 10500 092 / VE 3



4 014970 420177

Flieder / Gold
8006 10500 038 / VE 3



4 014970 420160

Eucalyptus/Crème/Lila/Flieder
4 x 3 sortiert · assorted · assorties



8006 10500 666 / VE 1



4 014970 421198

KREATIV-ACCESSOIRES GARNE

TWINES · FILS

Multi Colour Garn / 3 mm
9x in Verkaufsbox



8009 10500 999 / VE 9



4 014970 410079



8009 10510 999 / VE 8



4 014970 410116

8x3 sortiert · assorted · assorties

Baumwollgarn mit irrisierendem Faden · cotton yarn with iridescent thread · fil de coton avec fil iridescent
50 m / 3 mm



8007 10500 012 / VE 3



4 014970 381621



8007 10500 013 / VE 3



4 014970 381638



8007 10500 014 / VE 3



4 014970 381645



8007 10500 060 / VE 3



4 014970 381652

4 x 3 sortiert · assorted · assorties



8007 10500 999 / VE 1



4 014970 381669

BÄNDER KREATIV-ACCESSOIRES

RIBBONS · RUBANS

2 m / 15 mm

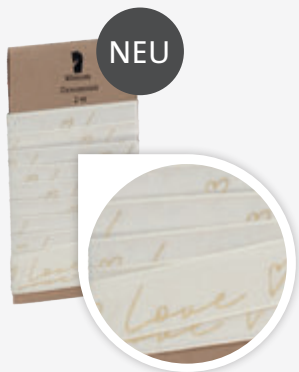

8000 3005 017 / VE 8



2 m / 12 mm

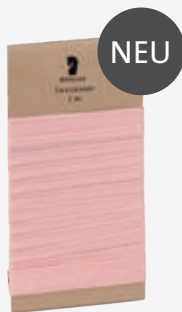

8000 3005 018 / VE 8



2 m / 12 mm



8000 3005 019 / VE 8



2 m / 12 mm

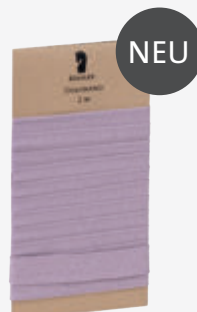

8000 3005 020 / VE 8



2 m / 23 mm



8000 3005 001 / VE 8



2 m / 23 mm



8000 3005 002 / VE 8



2 m / 23 mm

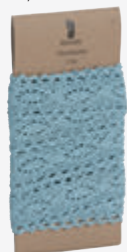

8000 3005 007 / VE 8



2 m / 15 mm



8000 3005 003 / VE 8



3 m / 2-3 mm



8000 3005 006 / VE 8



3 m / 6 mm



8000 3005 014 / VE 8



2 m / 15 mm

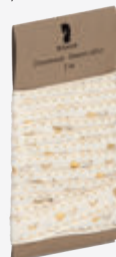

8000 3005 015 / VE 8



2 m / 15 mm



8000 3005 016 / VE 8



Satinband – 3 m / 3 mm



8001 3005 009 / VE 10



8001 3005 012 / VE 10



8001 3005 628 / VE 10



8001 3005 000 / VE 10



8001 3005 035 / VE 10



8001 3005 038 / VE 10



KREATIV-ACCESSOIRES BOXEN
BOXES · BOÎTES



BOXEN KREATIV-ACCESSOIRES

BOXES · BOÎTES

140 x 190 x 60 mm



Powder Metallic
1352 1190 004 / VE 3



140 x 190 x 60 mm



Taupe Metallic
1352 1191 003 / VE 3



140 x 190 x 60 mm



Terra Vanilla
1352 1192 023 / VE 3



140 x 190 x 60 mm



Kraft
1352 1192 623 / VE 3



140 x 190 x 60 mm



Terra Denim
1352 1192 626 / VE 3



140 x 190 x 60 mm



Cotton
1352 1192 627 / VE 3



140 x 190 x 60 mm



Rose
1352 1192 633 / VE 3



140 x 190 x 60 mm



Eucalyptus
1352 1192 673 / VE 3



KREATIV-ACCESSOIRES CREATIVE TAPES

10 m x 15 mm



8010 10520 016 / VE 6

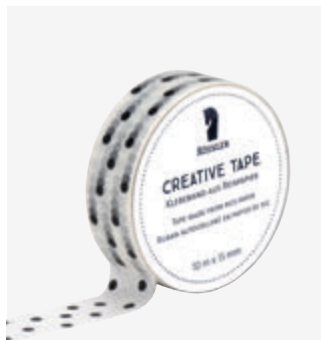

8010 10520 017 / VE 6

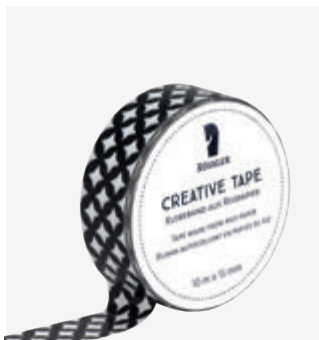

8010 10520 018 / VE 6

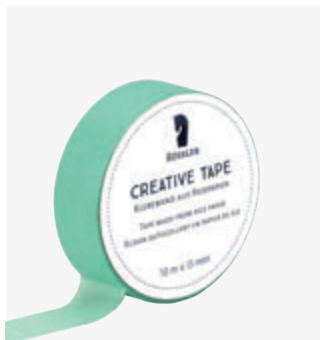

8010 10520 019 / VE 6

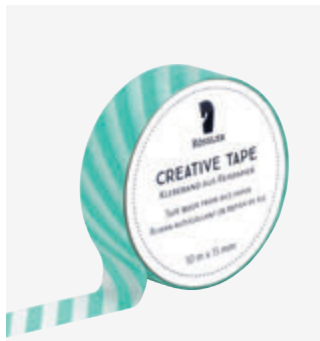

8010 10520 020 / VE 6

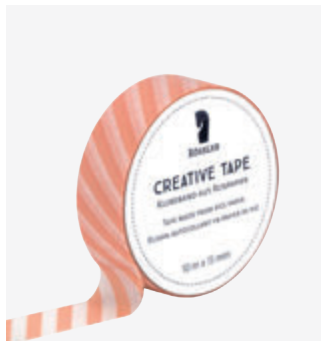

8010 10520 021 / VE 6



8010 10520 022 / VE 6

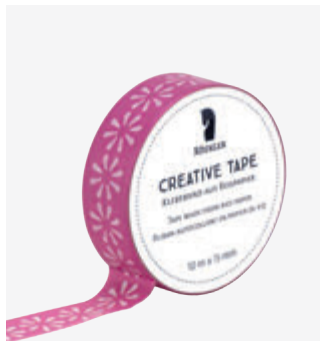

8010 10520 023 / VE 6



8010 10520 024 / VE 6



8010 10520 025 / VE 6

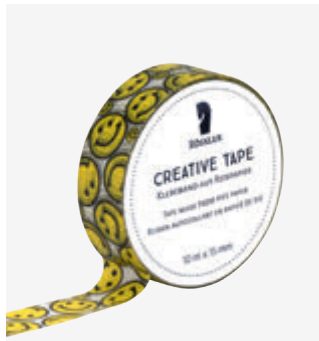

8010 10520 026 / VE 6

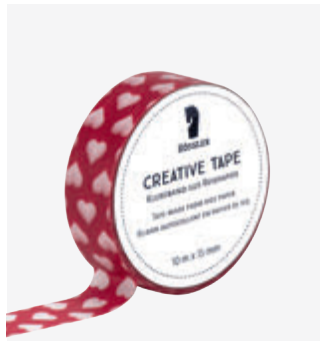

8010 10520 027 / VE 6

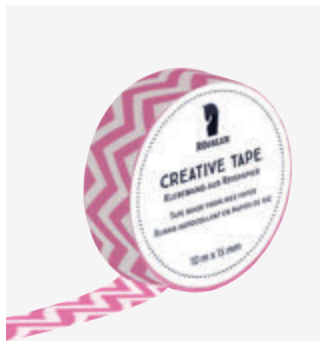

8010 10520 029 / VE 6

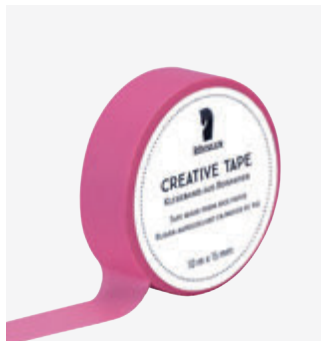

8010 10520 030 / VE 6

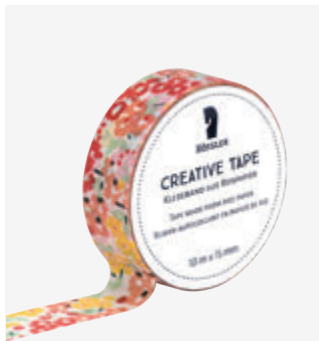

8010 10520 031 / VE 6



CREATIVE TAPES KREATIV-ACCESSOIRES

10 m x 15 mm



8010 10521 013 / VE 6



8010 10521 014 / VE 6

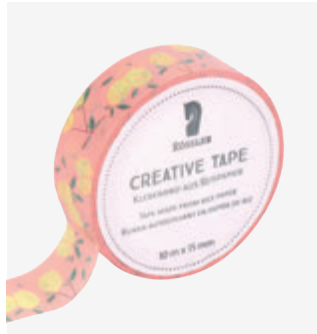

8010 10521 015 / VE 6



8010 10521 016 / VE 6



8010 10521 017 / VE 6

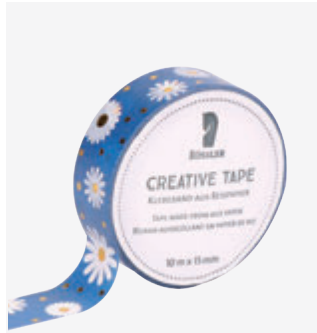

8010 10521 018 / VE 6



Heißfolie Gold
8010 10521 019 / VE 6

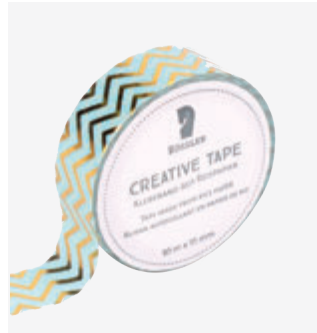

Heißfolie Gold
8010 10521 020 / VE 6



8010 10521 021 / VE 6
Neue Nr. für 8010 10520 012

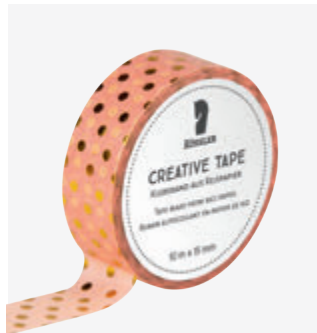

Heißfolie Gold
8010 10521 001 / VE 6



Heißfolie Gold
8010 10521 002 / VE 6



Heißfolie Gold
8010 10521 003 / VE 6

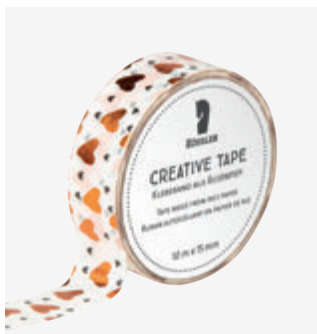

Heißfolie Roségold
8010 10521 004 / VE 6



Heißfolie Roségold
8010 10521 005 / VE 6



8010 10521 006 / VE 6

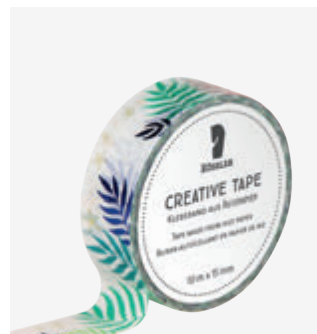

8010 10521 007 / VE 6



KREATIV-ACCESSOIRES CREATIVE TAPES

10 m x 15 mm



8010 10521 008 / VE 6



8010 10521 009 / VE 6



8010 10521 010 / VE 6



8010 10521 011 / VE 6



8010 10521 012 / VE 6



Heißfolie Gold
8010 10522 001 / VE 6



Heißfolie Gold
8010 10522 003 / VE 6

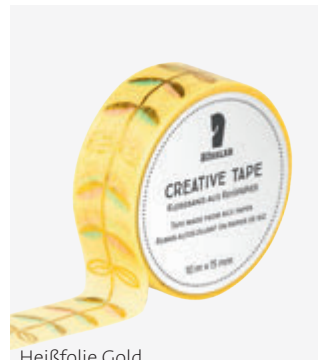

Heißfolie Gold
8010 10522 004 / VE 6



Heißfolie Gold
8010 10522 005 / VE 6



Heißfolie Gold
8010 10522 006 / VE 6



Heißfolie Gold
8010 10522 007 / VE 6



8010 10520 001 / VE 6



Heißfolie Gold
8010 10520 009 / VE 6



Heißfolie Gold
8010 10520 010 / VE 6



Heißfolie Gold
8010 10520 013 / VE 6



Heißfolie Gold
8010 10520 015 / VE 6



CREATIVE TAPES KREATIV-ACCESSOIRES

5 m x 15 mm



Glitter Pink
8010 10523 010 / VE 6



Glitter Blue
8010 10523 011 / VE 6



Glitter Rusty
8010 10523 012 / VE 6



Glitter Smaragd
8010 10523 013 / VE 6



Glitter Silver
8010 10523 014 / VE 6



Glitter Gold
8010 10523 015 / VE 6



6 x 6 sortiert · assorted · assorties
Tapes mit Glitter



8010 10523 999 / VE 1



6 x 6 sortiert · assorted · assorties
Tapes mit Heißfolie ·
hot foil · impression

- 6x 8010 10521 001
- 6x 8010 10521 003
- 6x 8010 10521 004
- 6x 8010 10521 020 (neu)
- 6x 8010 10522 005
- 6x 8010 10522 007



8010 10522 991 / VE 1



6 x 6 sortiert · assorted · assorties

- 6x 8010 10521 006
- 6x 8010 10521 007
- 6x 8010 10521 008
- 6x 8010 10521 009
- 6x 8010 10521 010
- 6x 8010 10521 014 (neu)



8010 10522 992 / VE 1



Leer-Display für 36 Tapes
8010 10520 000 / VE 1



Leer-Display für
5x5 Tapes (25)
8010 999 / VE 1



NEU

10 m x 15 mm

WASHI-TAPES

für Hängepräsentation
10 m x 15 mm
Größe 65 x 105 x 22 mm

Verpackung inklusive Aufhängung ·
Packaging including suspension
Emballages, y compris la suspension
ca. 65 x 105 mm



Heißfolie Gold
8011 10521 001 / VE 4

4 014970 416347

Heißfolie Gold
8011 10521 002 / VE 4

4 014970 416354

Heißfolie Gold
8011 10521 003 / VE 4

4 014970 416361

Heißfolie Roségold
8011 10521 004 / VE 4

4 014970 416378

Heißfolie Roségold
8011 10521 005 / VE 4

4 014970 416385

8011 10521 006 / VE 4

4 014970 416309

8011 10521 009 / VE 4

4 014970 416316

8011 10521 012 / VE 4

4 014970 416323

8011 10521 014 / VE 4

4 014970 416330

Heißfolie Gold
8011 10521 020 / VE 4

4 014970 416392

Heißfolie Gold
8011 10521 021 / VE 4

4 014970 416408

Heißfolie Gold
8011 10522 007 / VE 4

4 014970 416415

HANGING TAPES KREATIV-ACCESSOIRES

10 m x 15 mm



CREATIVE
Tape
RÖSSLER

10 m x 15 mm
www.roessler.de

Heißfolie Gold
8011 10520 009 / VE 4



4 014970 416422



CREATIVE
Tape
RÖSSLER

10 m x 15 mm
www.roessler.de

Heißfolie Gold
8011 10520 010 / VE 4



4 014970 416439



CREATIVE
Tape
RÖSSLER

10 m x 15 mm
www.roessler.de

Heißfolie Gold
8011 10520 013 / VE 4



4 014970 416446



CREATIVE
Tape
RÖSSLER

10 m x 15 mm
www.roessler.de

Heißfolie Gold
8011 10520 015 / VE 4



4 014970 416255



CREATIVE
Tape
RÖSSLER

10 m x 15 mm
www.roessler.de

8011 10520 017 / VE 4



4 014970 416194



CREATIVE
Tape
RÖSSLER

10 m x 15 mm
www.roessler.de

8011 10520 019 / VE 4



4 014970 416200



CREATIVE
Tape
RÖSSLER

10 m x 15 mm
www.roessler.de

8011 10520 020 / VE 4



4 014970 416217



CREATIVE
Tape
RÖSSLER

10 m x 15 mm
www.roessler.de

8011 10520 021 / VE 4



4 014970 416224



CREATIVE
Tape
RÖSSLER

10 m x 15 mm
www.roessler.de

8011 10520 022 / VE 4



4 014970 416231



CREATIVE
Tape
RÖSSLER

10 m x 15 mm
www.roessler.de

8011 10520 026 / VE 4



4 014970 416248



CREATIVE
Tape
RÖSSLER

10 m x 15 mm
www.roessler.de

8011 10520 027 / VE 4



4 014970 416262



CREATIVE
Tape
RÖSSLER

10 m x 15 mm
www.roessler.de

8011 10520 029 / VE 4



4 014970 416279



CREATIVE
Tape
RÖSSLER

10 m x 15 mm
www.roessler.de

8011 10520 030 / VE 4



4 014970 416286



CREATIVE
Tape
RÖSSLER

10 m x 15 mm
www.roessler.de

8011 10520 031 / VE 4



4 014970 416293



KREATIV-WELT WEIHNACHTEN STEMPEL & STEMPELKISSEN

VIELE WEITERE
WOODIES IM SORTIMENT.
SPRECHEN SIE UNS
GERNE AN!
Many more Woodies in
the range. We are happy
to advise you!

WOODIES
EIN
LA
DUNG

30 mm

W02006 / VE3

8 712938 068947

Mit
LIEBE
selbst gemacht

W05002 / VE3

8 712938 069203

W18004 / VE3

5 420078 606822

W19002 / VE3

5 420078 606891

W20003 / VE3

5 420078 606990

W22008 / VE3

5 420078 607225

STEMPELKISSEN

für unsere Woodies Stempel

WOODIES
Caribbean
Cuck

W99002

8 712938 069609

WOODIES
Royal
Rose

W99005

8 712938 069630

WOODIES
Beautiful
Berry

W99007

8 712938 069654

WOODIES
Marvellous
Magnolia

W99013

8 712938 069715

WOODIES
Deep
Dark

W99014

8 712938 069722

WOODIES
Fir
Forest

W99019

8 712938 069777

WOODIES
Soft
Snow

W99022

8 712938 069807



© May & Berry



MB0001 – 45 x 45 mm / VE 3



5 420078 610201



MB0002 – 45 x 45 mm / VE 3



5 420078 610218



MB0003 – 45 x 45 mm / VE 3



5 420078 610225



MB0004 – 45 x 45 mm / VE 3



5 420078 610232



MB0005 – 45 x 45 mm / VE 3



5 420078 610249



MB0006 – 45 x 45 mm / VE 3



5 420078 610256



MB0007 – 45 x 45 mm / VE 3



5 420078 610263



MB0008 – 45 x 45 mm / VE 3



5 420078 610270

KREATIV-ACCESSOIRES STEMPEL

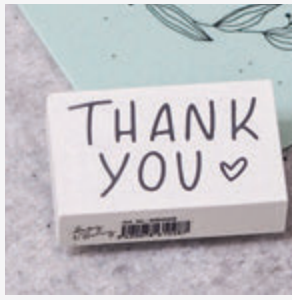

MB0009 – 35 x 55 mm / VE 3



5 420078 610287



MB0010 – 35 x 55 mm / VE 3



5 420078 610294



MB0011 – 35 x 55 mm / VE 3



5 420078 610300



MB0012 – 35 x 55 mm / VE 3



5 420078 610317



MB0013 – 35 x 55 mm / VE 3



5 420078 610324



MB0014 – 35 x 55 mm / VE 3



5 420078 610331



MB0016 – 35 x 55 mm / VE 3



5 420078 610355



MB0017 – 35 x 45 mm / VE 3



5 420078 610362



MB0019 – 35 x 45 mm / VE 3



5 420078 610386



MB0020 – 35 x 45 mm / VE 3



5 420078 610393



MB0021 – 35 x 45 mm / VE 3



5 420078 610409



MB0022 – 35 x 45 mm / VE 3



5 420078 610416



MB0023 – 35 x 45 mm / VE 3



5 420078 610423



MB0024 – 35 x 45 mm / VE 3



5 420078 610430



MB0047 – 45 x 45 mm / VE 3



5 420078 611161



MB0052 – 45 x 45 mm / VE 3



5 420078 611215

STEMPEL KREATIV-ACCESSOIRES

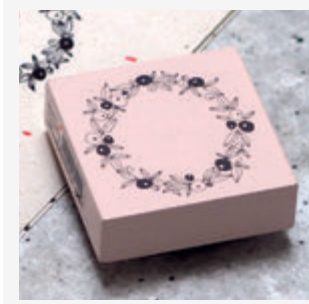

MB0053 – 45 x 45 mm / VE 3



5 420078 611222



MB0054 – 45 x 45 mm / VE 3



5 420078 611239



MB0055 – 45 x 45 mm / VE 3



5 420078 611246



MB0056 – 45 x 45 mm / VE 3



5 420078 611253



MB0057 – 35 x 55 mm / VE 3



5 420078 611260



MB0058 – 35 x 55 mm / VE 3



5 420078 611277



MB0059 – 35 x 55 mm / VE 3



5 420078 611284



MB0060 – 35 x 55 mm / VE 3



5 420078 611291



MB0061 – 35 x 55 mm / VE 3



5 420078 611307



MB0062 – 35 x 55 mm / VE 3



5 420078 611314



V01070 / VE 3



5 420078 609052



V01071 / VE 3



5 420078 609069



V01074 / VE 3



5 420078 609090



V01081 / VE 3



5 420078 609168

KREATIV-ACCESSOIRES STEMPEL & STEMPELKISSEN



V01064 / VE 3
5 420078 600646



V01069 / VE 3
5 420078 609045



V01082 / VE 3
5 420078 609175



V01088 / VE 3
5 420078 609236



V01008 / VE 3
5 420078 600080

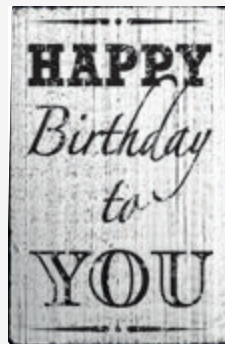

V01009 / VE 3
5 420078 600097



V01010 / VE 3
5 420078 600103



V01013 / VE 3
5 420078 600134



V01023 / VE 3
5 420078 600233



V01031 / VE 3
5 420078 600318



V01033 / VE 3
5 420078 600332



V01034 / VE 3
5 420078 600349



V01043 / VE 3
5 420078 600431



V01052 / VE 3
5 420078 600523



V00001 – SCHWARZ / VE 3
5 420078 600691

V00002 – ROT / VE 3
5 420078 602312



STICKER INSPIRIERENDE TRENDMOTIVE

Bezaubernde Sticker, mit denen Kreativsein ganz einfach wird! Zur optimalen Präsentation unseres vielfältigen Sticker-Sortiments bieten wir Ihnen verschiedene Drehsäulen an. Auch eine passgenaue Integration in die Paperado-Präsentation der losen Papiere ist möglich. Unser Vertrieb berät Sie gerne!

Die Sticker sind mit Preisgruppen **A** bis **F** ausgezeichnet. Die Preiszuordnung finden Sie in unserer Preisliste.

Enchanting stickers that make being creative easy! For the optimal presentation of our extensive range of stickers, various rotating column displays are available. Also for our bulk paper selection "Paperado" we offer the perfect display solution. Our sales team would be happy to advise you!

The stickers are marked with price groups **A** to **F**. You can find the price allocation in our price list.

Des stickers enchanteurs qui facilitent la créativité! Pour une présentation optimale de notre large gamme de stickers nous vous proposons différents présentoirs. Une intégration précise dans la présentation Paperado des papiers à la feuille est également possible. Notre équipe commerciale se fera un plaisir de vous conseiller!

Les autocollants sont classés dans les groupes de prix **A** à **F**. Vous trouverez l'affectation des prix dans notre liste de prix.





Sticker aus Reispapier
Rice Paper Stickers



STICKER AUS REISPAPIER
Rice Paper Stickers
Stickers en papier de riz



Originalgröße
ca. 25 x 25 mm

Verpackung inklusive Aufhängung ·
Packaging including suspension
Emballages, y compris la suspension
ca. 105 x 195 mm

„Just Fun“

A NEU 9200-8000 / VE 12

4 014970 428401

„Gardening“

A NEU 9200-8001 / VE 12

4 014970 428418

„Happy Birthday“

A NEU 9200-8002 / VE 12

4 014970 428425

„Summer Feelings“

A NEU 9200-8003 / VE 12

4 014970 428432

„Voyage“

A NEU 9200-8004 / VE 12

4 014970 428449

„Dogs and Cats“

A NEU 9200-8005 / VE 12

4 014970 428456

„Sweet Whishes“

A NEU 9200-8006 / VE 12

4 014970 428463

„Unicorn“

A NEU 9200-8007 / VE 12

4 014970 428470

NEU

HANDMADE STICKERS KREATIV-ACCESSOIRES



NEON

A NEU 9200-7206 / VE 12



4 014970 428371



NEON

A NEU 9200-7207 / VE 12



4 014970 428388



NEON

A NEU 9200-7208 / VE 12



4 014970 428395



Verpackung inklusive Aufhängung ·
Packaging including suspension
Emballages, y compris la suspension
ca. 105 x 185 mm

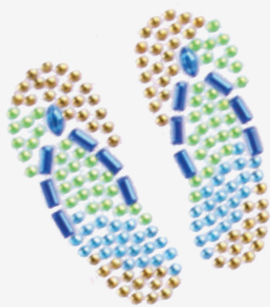

D NEU 9002-2070 / VE 6



4 014970 431203



D NEU 9002-2071 / VE 6



4 014970 431210



D NEU 9002-2072 / VE 6



4 014970 431227



D NEU 9002-2074 / VE 6



4 014970 431241



D NEU 9002-2073 / VE 6



4 014970 431234



D NEU 9002-2075 / VE 6



4 014970 437625



D NEU 9002-2077 / VE 6



4 014970 437649



D NEU 9002-2076 / VE 6



4 014970 437632



D NEU 9002-2078 / VE 6



4 014970 437656



D NEU 9007-294 / VE 6



4 014970 435942

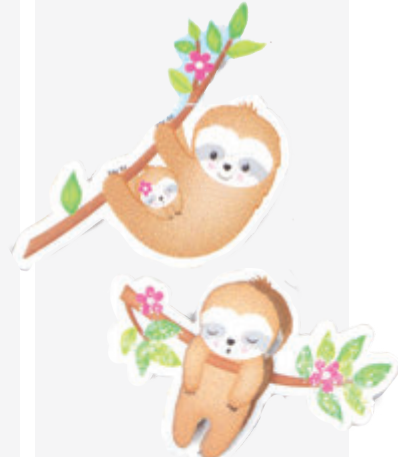

Verpackung inklusive Aufhängung · Packaging including suspension
Emballages, y compris la suspension
ca. 70 x 185 mm

Neu
New

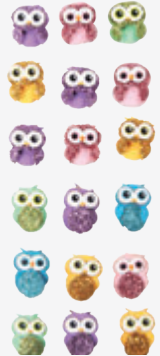

D NEU 9007-295 / VE 6



4 014970 435959



D NEU 9007-296 / VE 6



4 014970 435966



D NEU 9007-297 / VE 6



4 014970 435973



D NEU 9100-102 / VE 6



4 014970 428302



D NEU 9100-103 / VE 6



4 014970 428319



D NEU 9100-104 / VE 6



4 014970 428326



D NEU 9100-105 / VE 6



4 014970 428333

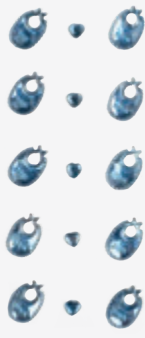

D NEU 9100-106 / VE 6



4 014970 428340

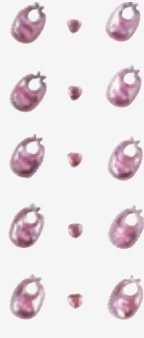

D NEU 9100-107 / VE 6



4 014970 428357

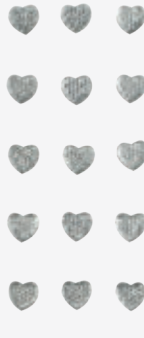

D NEU 9100-100 / VE 6



4 014970 428289

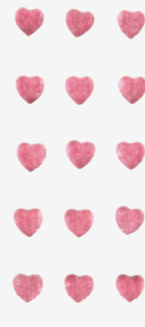

D NEU 9100-101 / VE 6



4 014970 428296



B NEU 9400-526 / VE 8



4 014970 433665



B NEU 9400-527 / VE 8



4 014970 433672



B NEU 9400-528 / VE 8



4 014970 433689

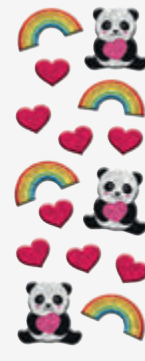

B NEU 9400-529 / VE 8



4 014970 433696

Neu
New

NEU

HANDMADE STICKERS KREATIV-ACCESSOIRES

A NEU 9500-526 / VE 12
4 014970 435331

A NEU 9500-528 / VE 12
4 014970 435355

A NEU 9500-529 / VE 12
4 014970 435362

B NEU 9510-100 / VE 8
4 014970 435249

B NEU 9510-101 / VE 8
4 014970 435256

B NEU 9510-102 / VE 8
4 014970 435263

B NEU 9510-103 / VE 8
4 014970 435270

B NEU 9510-104 / VE 8
4 014970 435287

B NEU 9510-105 / VE 8
4 014970 435294

B NEU 9510-106 / VE 8
4 014970 435300

B NEU 9510-107 / VE 8
4 014970 435317

B NEU 9510-108 / VE 8
4 014970 435324

B NEU 9511-000 / VE 8
4 014970 435904

B NEU 9511-002 / VE 8
4 014970 435928

B NEU 9511-001 / VE 8
4 014970 435911

Neu
New



HANDMADE PAPER STICKERS

Diese Sticker werden aus Papier hergestellt – mit viel Liebe zum Detail. Sie bezaubern mit einem einzigartigen natürlichen Charakter.

These stickers are made of paper. They have a unique natural character.

Ces autocollants sont fabriqués en papier. Ils ont un caractère naturel unique.



Handgefertigte Papier Sticker
Handmade Paper Stickers

HANDMADE PAPER STICKERS KREATIV-ACCESSOIRES

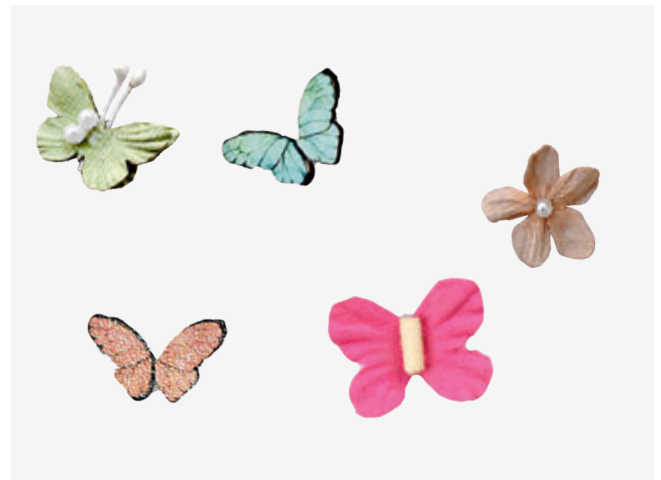
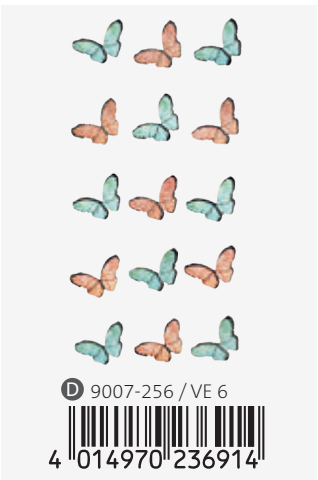
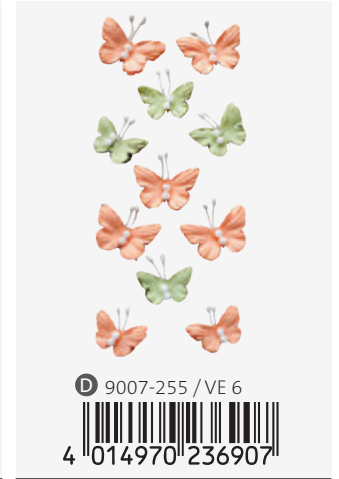
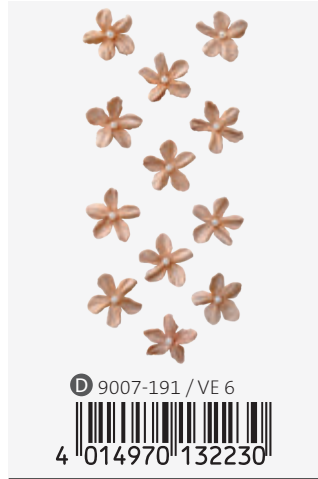
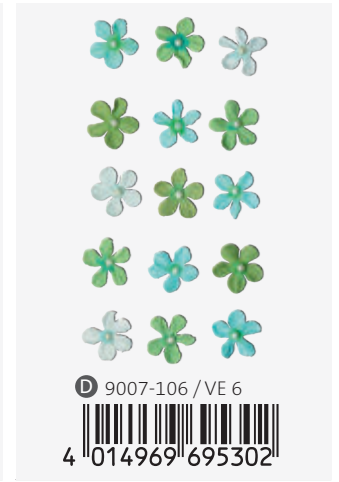
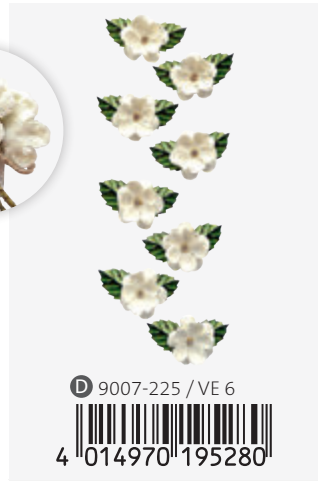
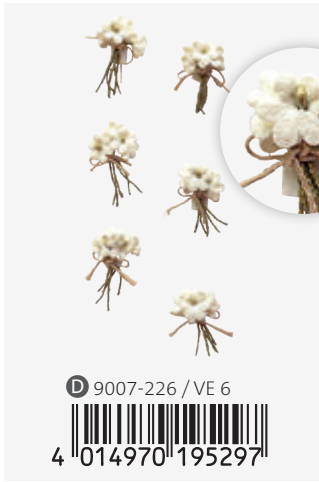
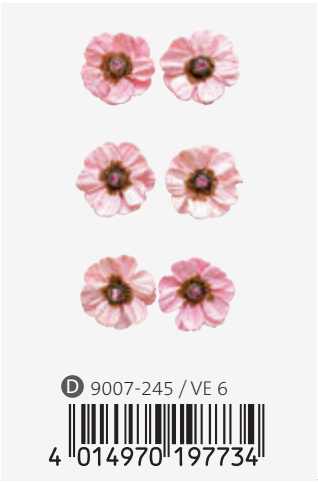

Handgefertigte Papier Sticker
Handmade Paper Stickers

Verpackung inklusive Aufhängung · Packaging including suspension
Emballages, y compris la suspension
ca. 70 x 185 mm

KREATIV-ACCESSOIRES HANDMADE STICKERS

Blumen
Flowers

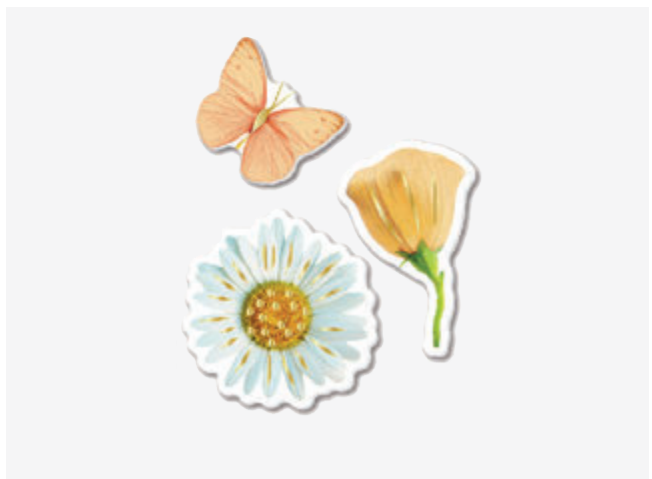
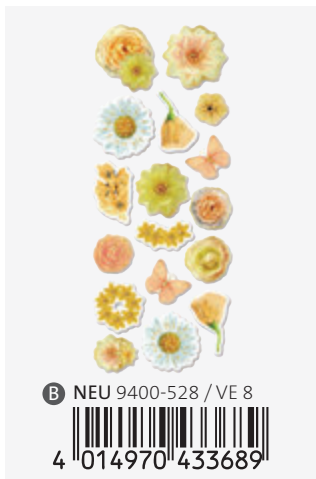
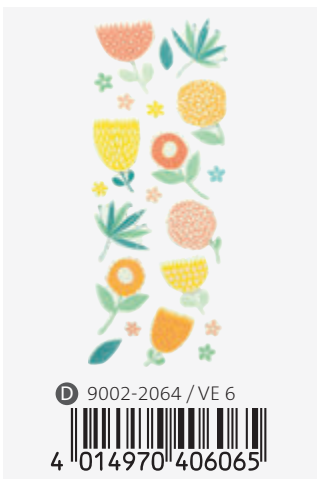
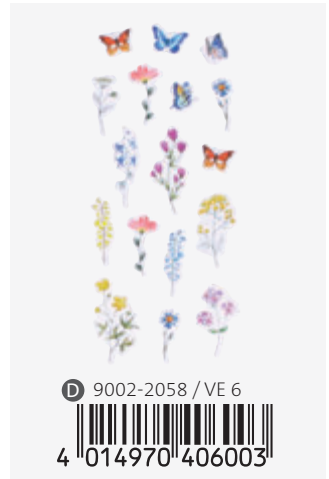
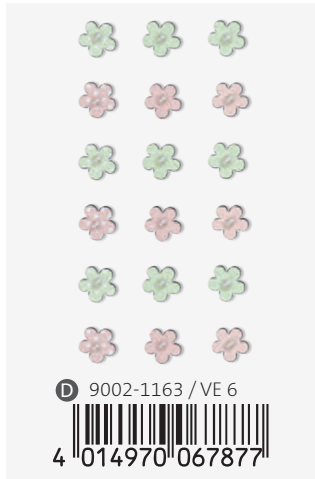
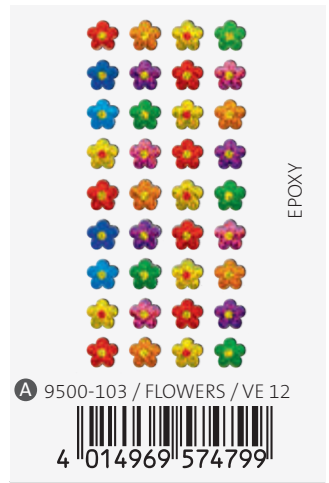
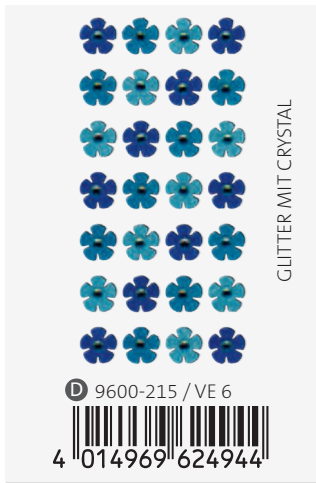
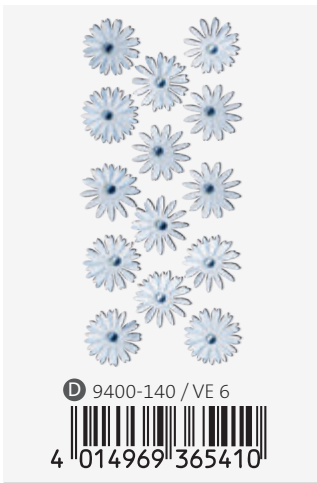
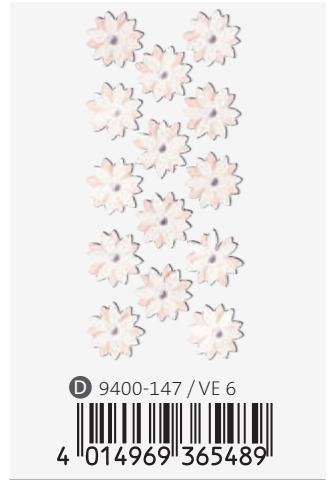
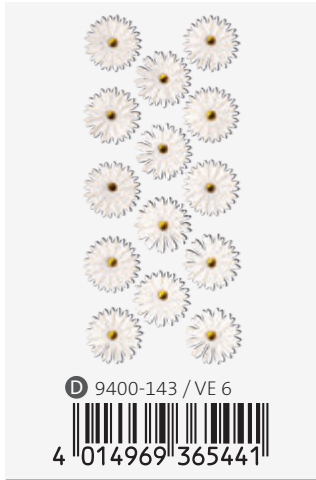
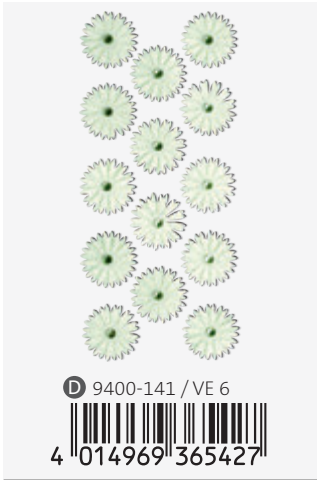

HANDMADE STICKERS KREATIV-ACCESSOIRES

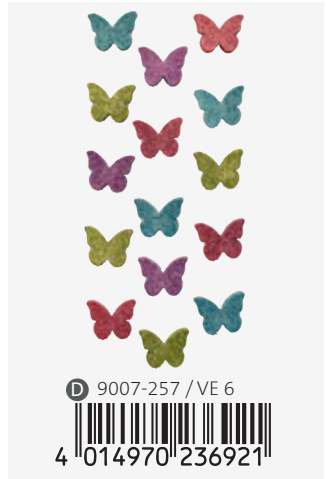
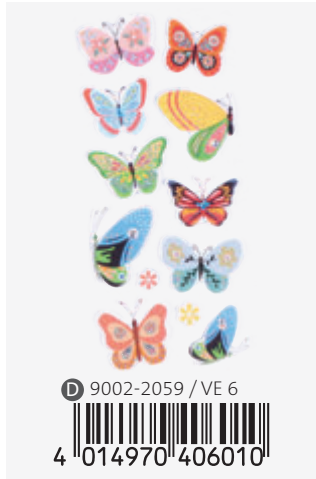
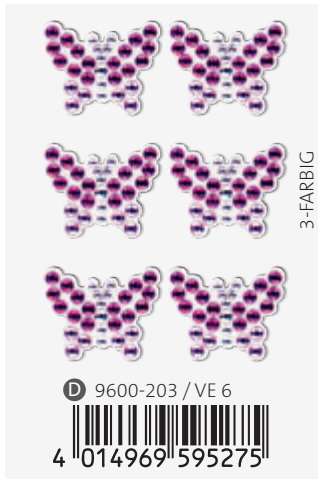
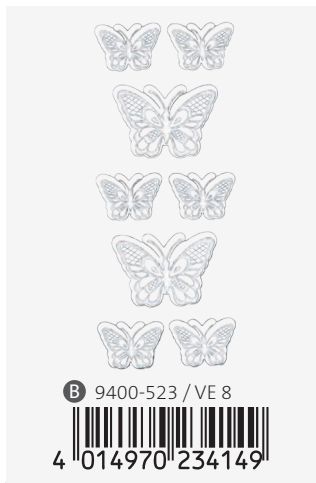
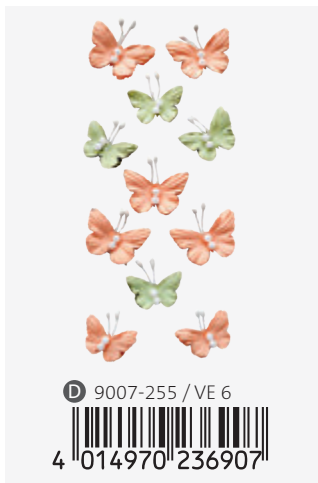
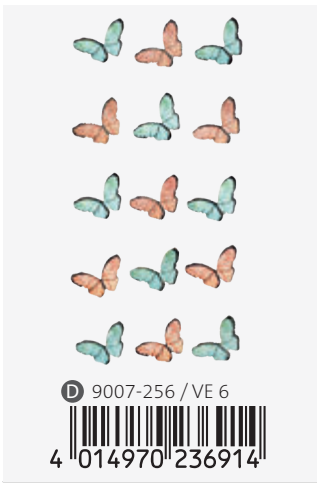
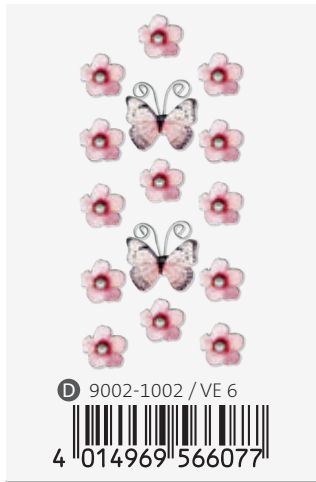
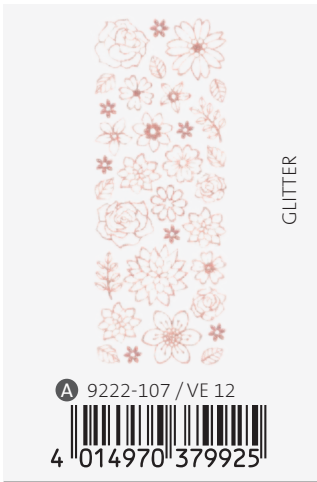

Schmetterlinge
Butterflies

KREATIV-ACCESSOIRES HANDMADE STICKERS



D 9002-2043 / VE 6



4 014970 379697



D 9002-2044 / VE 6



4 014970 379758



D 9002-2065 / VE 6



4 014970 406072



D 9002-2061 / VE 6



4 014970 406034



D 9002-2046 / VE 6



4 014970 379772



D 9002-2047 / VE 6



4 014970 380013

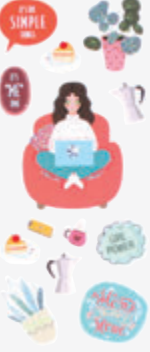

D 9002-2052 / VE 6



4 014970 379710

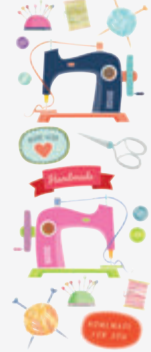

D 9002-2053 / VE 6



4 014970 379727



D 9002-2045 / VE 6



4 014970 379765



D NEU 9002-2075 / VE 6



4 014970 437625

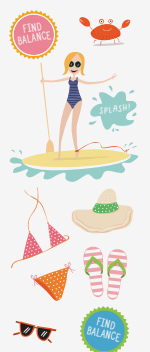

D NEU 9002-2077 / VE 6



4 014970 437649



D 9007-240 / VE 6



4 014970 195433



D 9007-270 / VE 6



4 014970 379840



D NEU 9007-297 / VE 6



4 014970 435973



D 9002-1168 / VE 6



4 014970 084294

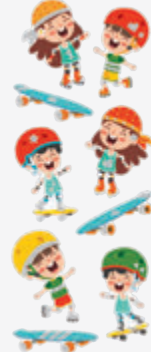

A NEU 9500-528 / VE 12



4 014970 435355

HANDMADE STICKERS KREATIV-ACCESSOIRES



B NEU 9511-001 / VE 8



4 014970 435911



D 9002-2017 / VE 6



4 014970 193835

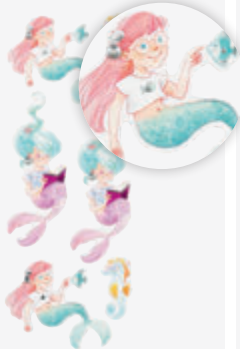

D 9002-1445 / VE 6



4 014970 223006



D 9002-2016 / VE 6



4 014970 193828



B NEU 9511-002 / VE 8



4 014970 435928



D 9002-1169 / VE 6



4 014970 084300



D 9002-2030 / VE 6



4 014970 229701



B NEU 9510-103 / VE 8



4 014970 435270



D 9002-2055 / VE 6



4 014970 379741



D 9002-1447 / VE 6



4 014970 223013

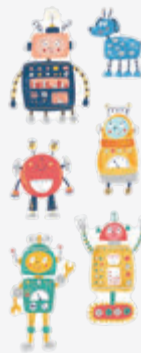

B NEU 9510-107 / VE 8



4 014970 435317



B NEU 9400-526 / VE 8



4 014970 433665



D NEU 9002-2071 / VE 6



4 014970 431210



D 9007-254 / VE 6



4 014970 236891



A NEU 9500-526 / VE 12



4 014970 435331

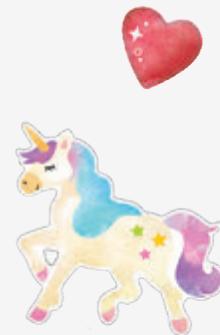

Kinder
Kids

KREATIV-ACCESSOIRES HANDMADE STICKERS

Tiere
Animals

B NEU 9400-529 / VE 8
4 014970 433696

D NEU 9007-294 / VE 6
4 014970 435942

D 9002-2015 / VE 6
4 014970 193811

D 9002-2001 / VE 6
4 014970 178887

D 9002-2029 / VE 6
4 014970 229695

D 9002-2066 / VE 6
4 014970 406089

D 9002-2067 / VE 6
4 014970 406096

D 9002-2032 / VE 6
4 014970 232114

D 9007-266 / VE 6
4 014970 379802

D 9007-200 / VE 6
4 014970 151293

B NEU 9511-000 / VE 8
4 014970 435904

D 9002-2003 / VE 6
4 014970 178900

A 9500-515 / VE 12
4 014969 674482

B 9400-524 / VE 8
4 014970 234156

D 9002-2054 / VE 6
4 014970 379734

D 9007-212 / VE 6
4 014970 153587

D NEU 9007-296 / VE 6
4 014970 435966

D 9007-202 / VE 6
4 014970 151316

D 9007-258 / VE 6
4 014970 236938

D NEU 9007-295 / VE 6
4 014970 435959

A 9500-514 / HAPPY STICKER / VE 12
4 014969 674475

B 9500-178 / VE 8
4 014970 151095

D 9007-198 / VE 6
4 014970 151279

B 9500-182 / VE 8
4 014970 151132

D NEU 9002-2074 / VE 6
4 014970 431241

D NEU 9002-2073 / VE 6
4 014970 431234

A 9500-505 / VE 12
4 014969 607497

B 9400-509 / VE 8
4 014970 083969

D 9007-267 / VE 6
4 014970 379819

Tiere
Animals

KREATIV-ACCESSOIRES HANDMADE STICKERS

Gute Laune
Fun Times

D 9007-268 / VE 6
4 014970 379826

D 9002-2048 / VE 6
4 014970 380020

B NEU 9510-100 / VE 8
4 014970 435249

A 9500-208 / VE 12
4 014970 379963

NEON

D 9007-149 / VE 6
4 014970 082887

B 9400-525 / VE 8
4 014970 234163

A 9500-209 / VE 12
4 014970 379970

NEON

A 9500-200 / VE 12
4 014970 234200

NEON

B 9400-506 / VE 8
4 014970 083914

A 9500-104 / VE 12
4 014969 574805

EPOXY

A 9500-103 / VE 12
4 014969 574799

EPOXY

D 9002-1044 / VE 6
4 014969 595350

D 9007-147 / VE 6
4 014970 082863

B 9500-181 / VE 8
4 014970 151125

D 9100-038 / VE 6
4 014969 566534

D 9100-071 / VE 6
4 014969 675489

HANDMADE STICKERS KREATIV-ACCESSOIRES

D 9100-072 / VE 6
4 014969 675496

D 9002-2060 / VE 6
4 014970 406027

B NEU 9510-102 / VE 8
4 014970 435263

B 9500-212 / VE 8
4 014970 380006

D 9007-264 / VE 6
4 014970 379789

D 9007-265 / VE 6
4 014970 379796

D 9007-269 / VE 6
4 014970 379833

D 9007-172 / VE 6
4 014970 116667

D 9007-173 / VE 6
4 014970 116674

A 9500-504 / VE 12
4 014969 607480

A 9222-105 / VE 12
4 014970 379901

GLITTER

A 9222-106 / VE 12
4 014970 379918

GLITTER

A 9500-519 / VE 12
4 014969 675533

D 9007-151 / VE 6
4 014970 082900

D 9002-2031 / VE 6
4 014970 229718

D 9007-260 / VE 6
4 014970 236952

Geburtstag
Happy Birthday

KREATIV-ACCESSOIRES HANDMADE STICKERS



B NEU 9510-105 / VE 8



4 014970 435294



D 9007-233 / VE 6



4 014970 195365



D NEU 9002-2072 / VE 6



4 014970 431227



D NEU 9002-2070 / VE 6



4 014970 431203

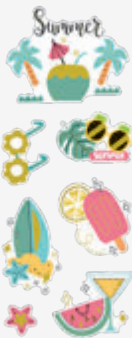

B NEU 9510-104 / VE 8



4 014970 435287



NEON

A 9500-201 / VE 12



4 014970 234217



B NEU 9510-101 / VE 8



4 014970 435256

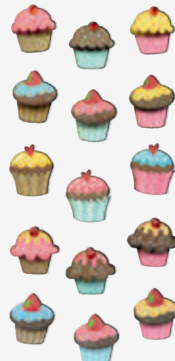

D 9007-204 / VE 6



4 014970 151330



D 9002-1170 / VE 6



4 014970 084317



D 9007-228 / VE 6



4 014970 195310



D 9600-222 / VE 6



4 014970 154515



D 9007-232 / VE 6



4 014970 195358

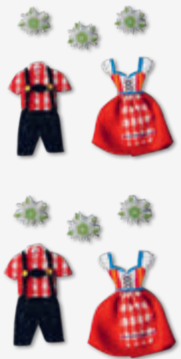

D 9100-049 / VE 6



4 014969 631188



D 9100-050 / VE 6



4 014969 631195



2 Bogen · sheets · feuilles

B 9500-188 / VE 8

4 014970 194467

D 9400-153 / VE 6

4 014970 194412

D 9400-154 / VE 6

4 014970 194429

B 9500-189 / VE 8

4 014970 234187

2 Bogen · sheets · feuilles

2 Bogen · sheets · feuilles

B 9500-190 / VE 8

4 014970 234194

2 Bogen · sheets · feuilles

B 9500-185 / VE 8

4 014970 194436

2 Bogen · sheets · feuilles

B 9500-187 / VE 8

4 014970 194450

2 Bogen · sheets · feuilles

B 9500-210 / VE 8

4 014970 379987

2 Bogen · sheets · feuilles

B 9500-211 / VE 8

4 014970 379994

Verpackung ca. 100 x 190 mm

B 8015 1951 000 / VE 5

4 014970 419690

Verpackung ca. 100 x 190 mm

B 8015 1952 000 / VE 5

4 014970 419706

4 Bogen · sheets · feuilles

NEU 9012-101 / VE 6

4 014970 419607

MY JOURNAL STICKERS
& STICKY NOTES

Ideal zum Gestalten von Bullet Journals.
Ideal for designing bullet journals.
Idéal pour la conception des journaux bullet.



KREATIV-ACCESSOIRES HANDMADE STICKERS

Einladung & Feiern
Festivities

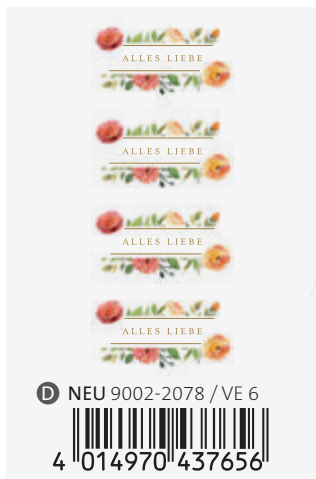
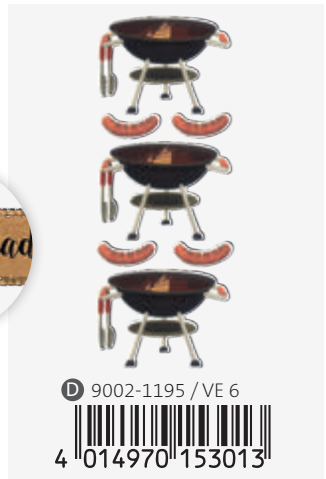
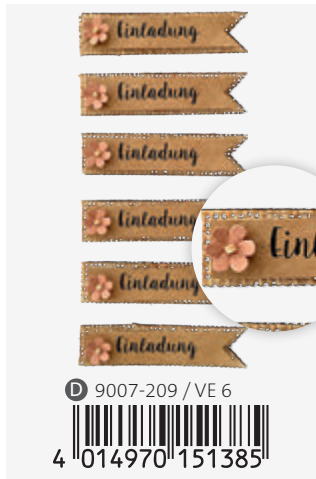
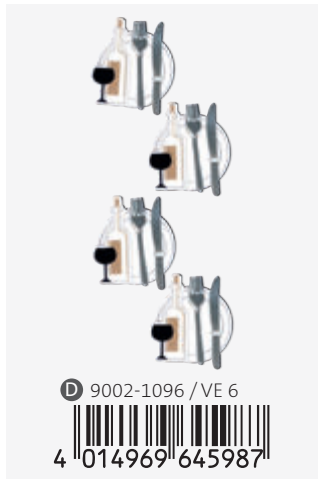
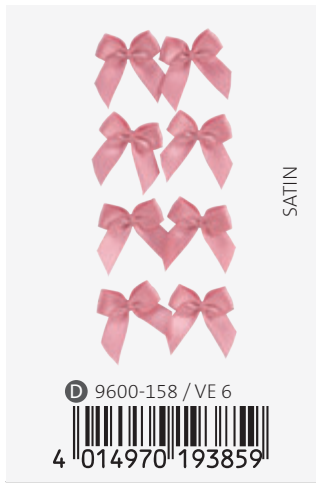
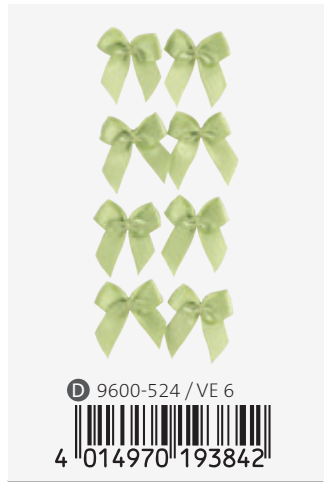
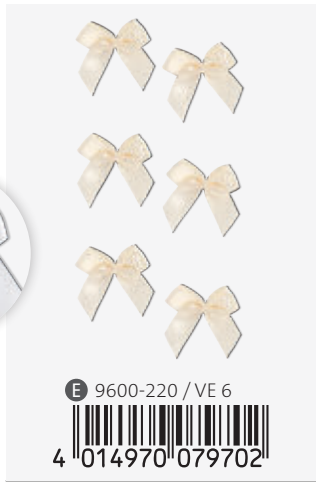
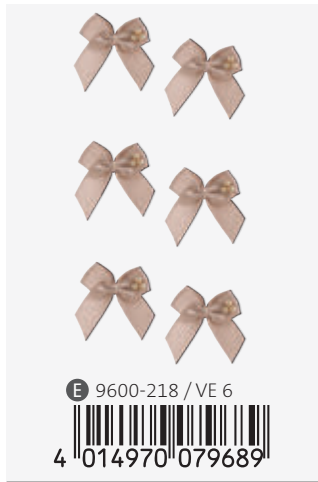

HANDMADE STICKERS KREATIV-ACCESSOIRES

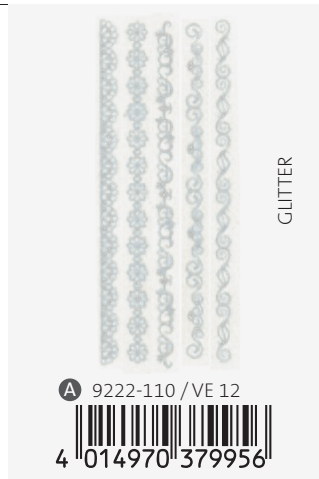
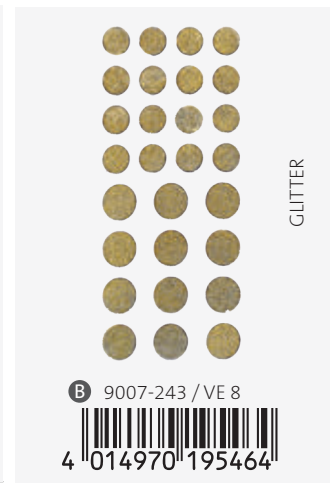
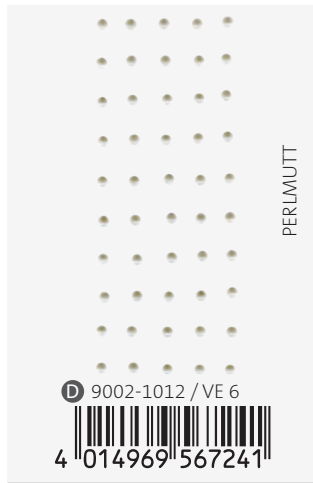
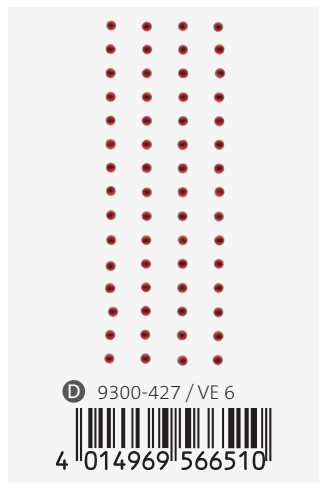
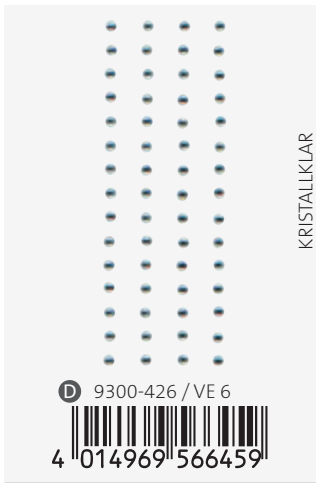
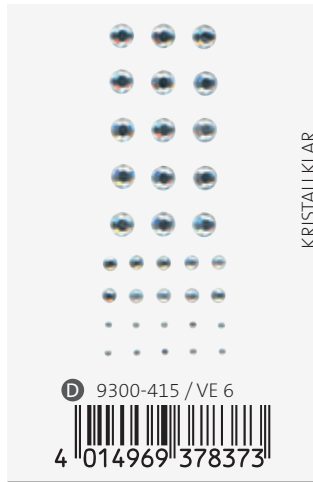
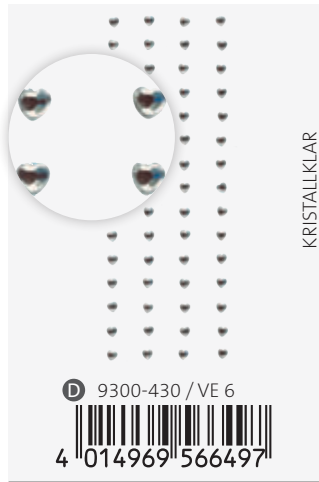
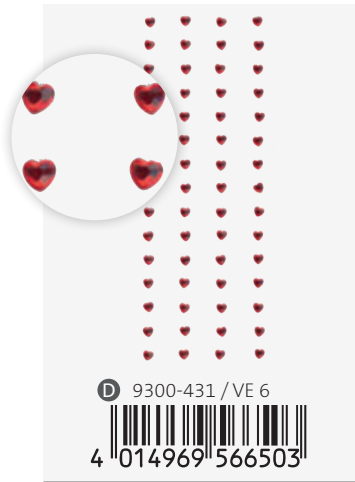

Glitzer
Glitter

KREATIV-ACCESSOIRES HANDMADE STICKERS

Liebe
Love

A 9500-102 / VE 12
4 014969 574782

B NEU 9400-527 / VE 8
4 014970 433672

B 9400-513 / VE 8
4 014970 084034

A 9500-202 / VE 12
4 014970 234224

NEON

B 9400-522 / VE 8
4 014970 234132

B 9400-521 / VE 8
4 014970 234170

D 9002-2068 / VE 6
4 014970 406102

D 9002-2069 / VE 6
4 014970 406119

D 9007-206 / VE 6
4 014970 151354

D 9007-205 / VE 6
4 014970 151347

D 9002-1000 / VE 6
4 014969 566053

E 9600-204 / VE 6 *
4 014969 595282

E 9600-205 / VE 6
4 014969 595299

CRYSTALS

D 9300-442 / KRISTALLKLAR / VE 6
4 014969 568620

CRYSTALS

D NEU 9100-100 / VE 6
4 014970 428289

CRYSTALS

D NEU 9100-101 / VE 6
4 014970 428296

CRYSTALS

HANDMADE STICKERS KREATIV-ACCESSOIRES

D 9002-1001 / VE 6
4 014969 566060

D 9003-103 / VE 6
4 014969 542248

D 9002-1167 / VE 6
4 014970 082993

D 9002-1191 / VE 6
4 014970 132063

D 9002-1013 / VE 6
4 014969 567258

D NEU 9100-104 / VE 6
4 014970 428326

D 9002-1012 / VE 6
4 014969 567241

D 9002-920 / VE 6
4 014969 393499

D 9002-1003 / VE 6
4 014969 566084

D 9002-1004 / VE 6
4 014969 566091

D 9007-259 / VE 6
4 014970 236945

D 9600-223 / VE 6
4 014970 154522

D 9007-242 / VE 6
4 014970 195457

GLITTER

D 9007-238 / VE 6
4 014970 195419

D 9002-2049 / VE 6
4 014970 380037

D 9002-2050 / VE 6
4 014970 379703

Liebe
Love

KREATIV-ACCESSOIRES HANDMADE STICKERS

Baby

D 9007-224 / VE 6
4 014970 195273

D 9007-223 / VE 6
4 014970 195266

D 9100-023 / VE 6
4 014969 536360

D 9100-024 / VE 6
4 014969 536377

D 9100-042 / VE 6
4 014969 566572

D 9100-041 / VE 6
4 014969 566565

D 9002-2056 / VE 6
4 014970 405983

D 9002-2057 / VE 6
4 014970 405990

D 9007-271 / VE 6
4 014970 379857

D 9007-272 / VE 6
4 014970 379864

D NEU 9100-106 / VE 6
4 014970 428340

D NEU 9100-107 / VE 6
4 014970 428357

D 9007-194 / VE 6
4 014970 151231

D 9007-195 / VE 6
4 014970 151248



Produktionsbedingte Änderungen vorbehalten.
May be subject to modification for production reasons.
La production sujette à des modifications.

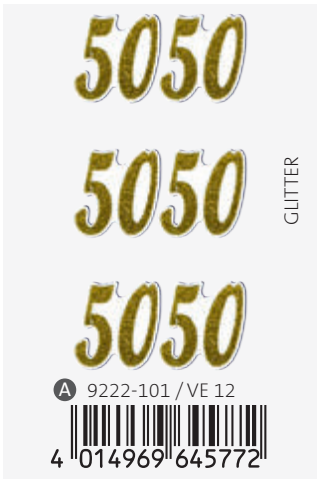
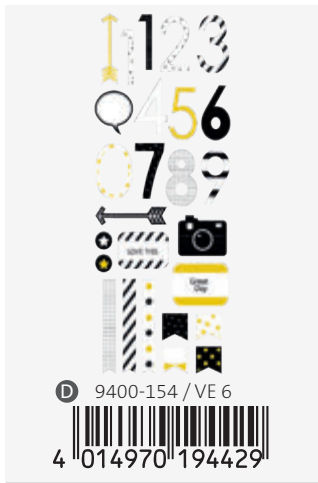
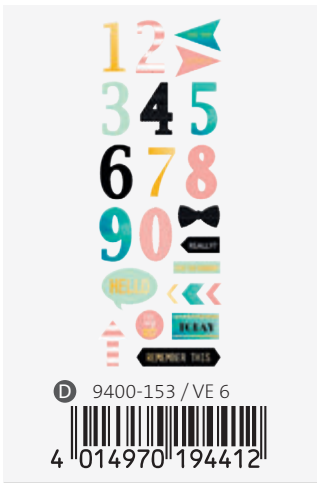
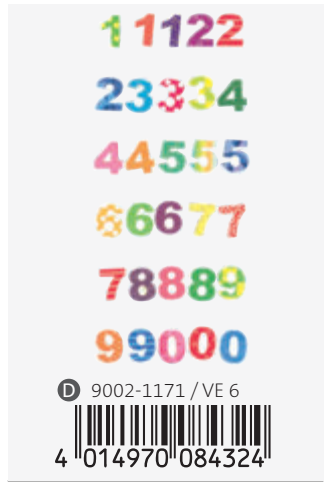
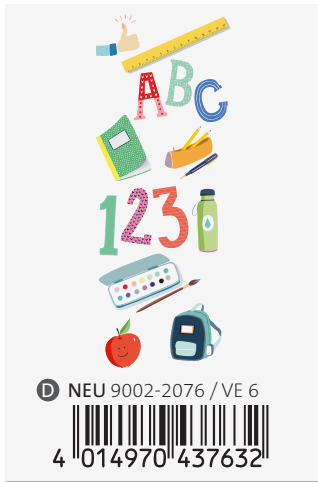

Zahlen
Numbers

KREATIV-ACCESSOIRES HANDMADE STICKERS



D 9002-1181 / VE 6
4 014970 110078



D 9007-261 / VE 6
4 014970 237249



D 9007-262 / VE 6
4 014970 237256



D 9002-1118 / VE 6
4 014969 674468



D 9002-2000 / VE 6
4 014970 153068



D 9002-997 / VE 6
4 014969 560679

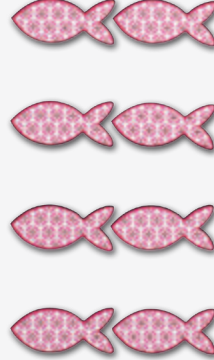

D 9002-1160 / VE 6
4 014970 067822

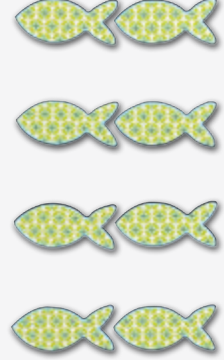

D 9002-1161 / VE 6
4 014970 067839



D 9002-1196 / VE 6
4 014970 153020



D 9002-1197 / VE 6
4 014970 153037



D 9002-1198 / VE 6
4 014970 153044

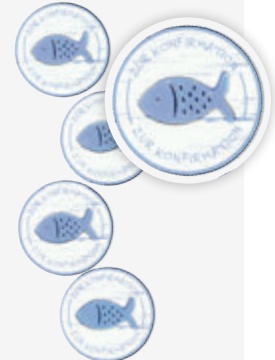

D 9002-1199 / VE 6
4 014970 153051



D 9002-2018 / VE 6
4 014970 193866



E 9600-217 / VE 6
4 014970 079672



D 9002-2019 / VE 6
4 014970 193873



D 9002-1116 / VE 6
4 014969 674444

Kommunion & Konfirmation
Communion & Confirmation



Sticker aus Reispapier
Rice Paper Stickers



STICKER AUS REISPAPIER
Rice Paper Stickers
Stickers en papier de riz



Originalgröße
ca. 25 x 25 mm

Verpackung inklusive Aufhängung -
Packaging including suspension
Emballages, y compris la suspension
ca. 105 x 195 mm

„Just Fun“

A NEU 9200-8000 / VE 12

4 014970 428401

„Gardening“

A NEU 9200-8001 / VE 12

4 014970 428418

„Happy Birthday“

A NEU 9200-8002 / VE 12

4 014970 428425

„Summer Feelings“

A NEU 9200-8003 / VE 12

4 014970 428432

„Voyage“

A NEU 9200-8004 / VE 12

4 014970 428449

„Dogs and Cats“

A NEU 9200-8005 / VE 12

4 014970 428456

„Sweet Whishes“

A NEU 9200-8006 / VE 12

4 014970 428463

„Unicorn“

A NEU 9200-8007 / VE 12

4 014970 428470

Produktionsbedingte Änderungen vorbehalten.
May be subject to modification for production reasons.
La production sujette à des modifications.

NEU



NEON

A NEU 9200-7206 / VE 12
4 014970 428371



NEON

A NEU 9200-7207 / VE 12
4 014970 428388



NEON

A NEU 9200-7208 / VE 12
4 014970 428395

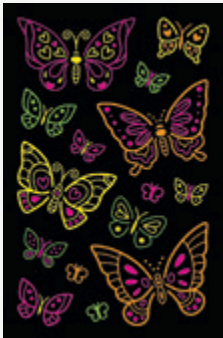

NEON

A 9200-7205 / VE 12
4 014970 379895



NEON

A 9200-7204 / VE 12
4 014970 379888



NEON

A 9200-7203 / VE 12
4 014970 379871



Verpackung inklusive Aufhängung -
Packaging including suspension
Emballages, y compris la suspension
ca. 105 x 185 mm

Neon

KREATIV-ACCESSOIRES PEEL-OFF STICKERS

F

18 18 18 18
18 18 18 18
18 18 18 18
18 18 18 18
18 18 18 18
18 18 18 18

 9200-7197 / VE 12
GOLD/GOLD/OR
4 014970 131646

 9200-7198 / VE 12
SILBER/SILVER/ARGENT
4 014970 131653

 9200-7199 / VE 12
WEISS/WHITE/BLANC
4 014970 131660

F

20 20 20
20 20 20
20 20 20
20 20 20
20 20 20
20 20 20

 9200-7200 / VE 12
GOLD/GOLD/OR
4 014970 131554

 9200-7201 / VE 12
SILBER/SILVER/ARGENT
4 014970 131561

 9200-7202 / VE 12
WEISS/WHITE/BLANC
4 014970 131578

F

25 25 25
25 25 25
25 25 25
25 25 25
25 25 25
25 25 25

 9200-7130 / VE 12
SILBER/SILVER/ARGENT
4 014970 131349

 9200-7009 / VE 12
WEISS/WHITE/BLANC
4 014970 131356

F

30 30 30
30 30 30
30 30 30
30 30 30
30 30 30
30 30 30

 9200-7163 / VE 12
GOLD/GOLD/OR
4 014970 131509

 9200-7164 / VE 12
SILBER/SILVER/ARGENT
4 014970 131516

 9200-7015 / VE 12
WEISS/WHITE/BLANC
4 014970 131080

F

40 40 40
40 40 40
40 40 40
40 40 40
40 40 40
40 40 40

 9200-7165 / VE 12
GOLD/GOLD/OR
4 014970 131097

 9200-7166 / VE 12
SILBER/SILVER/ARGENT
4 014970 131103

 9200-7016 / VE 12
WEISS/WHITE/BLANC
4 014970 131110

F

50 50 50
50 50 50
50 50 50
50 50 50
50 50 50
50 50 50

 9200-7131 / VE 12
GOLD/GOLD/OR
4 014970 131363

 9200-7132 / VE 12
SILBER/SILVER/ARGENT
4 014970 367663

 9200-7010 / VE 12
WEISS/WHITE/BLANC
4 014970 131370

F

60 60 60
60 60 60
60 60 60
60 60 60
60 60 60
60 60 60

 9200-7145 / VE 12
GOLD/GOLD/OR
4 014970 131431

 9200-7146 / VE 12
SILBER/SILVER/ARGENT
4 014970 131448

 9200-7012 / VE 12
WEISS/WHITE/BLANC
4 014970 131455

A

65 65 65
65 65 65
65 65 65
65 65 65
65 65 65
65 65 65

 9200-189 / VE 12
GOLD/GOLD/OR
4 014969 667170

 9200-190 / VE 12
SILBER/SILVER/ARGENT
4 014969 667187

F

70 70 70
70 70 70
70 70 70
70 70 70
70 70 70
70 70 70

 9200-7133 / VE 12
GOLD/GOLD/OR
4 014970 131387

 9200-7134 / VE 12
SILBER/SILVER/ARGENT
4 014970 131394

A

75 75 75
75 75 75
75 75 75
75 75 75
75 75 75
75 75 75

 9200-191 / VE 12
GOLD/GOLD/OR
4 014969 667194

 9200-192 / VE 12
SILBER/SILVER/ARGENT
4 014969 667200

PEEL-OFF STICKERS KREATIV-ACCESSOIRES

F  9200-7168 / VE 12
SILBER/SILVER/ARGENT
4 014970 131134

F  9200-7193 / VE 12
GOLD/GOLD/OR
4 014970 131608
9200-7194 / VE 12
SILBER/SILVER/ARGENT
4 014970 131615

F  9200-7195 / VE 12
GOLD/GOLD/OR
4 014970 131622
9200-7196 / VE 12
SILBER/SILVER/ARGENT
4 014970 131639

F  9200-1111 / VE 12
GOLD/GOLD/OR
4 014970 131226
9200-1112 / VE 12
SILBER/SILVER/ARGENT
4 014970 131233
9200-7003 / VE 12
WEISS/WHITE/BLANC
4 014970 131240

F  9200-1115 / VE 12
GOLD/GOLD/OR
4 014970 131257
9200-1116 / VE 12
SILBER/SILVER/ARGENT
4 014970 131264
9200-7004 / VE 12
WEISS/WHITE/BLANC
4 014970 131271

F  9200-7123 / VE 12
GOLD/GOLD/OR
4 014970 131318
9200-7124 / VE 12
SILBER/SILVER/ARGENT
4 014970 131325
9200-7006 / VE 12
WEISS/WHITE/BLANC
4 014970 131332

F  9200-1103 / VE 12
GOLD/GOLD/OR
4 014970 131172
9200-1104 / VE 12
SILBER/SILVER/ARGENT
4 014970 131189
9200-7002 / VE 12
WEISS/WHITE/BLANC
4 014970 131196

F  9200-7135 / VE 12
GOLD/GOLD/OR
4 014970 131400
9200-7136 / VE 12
SILBER/SILVER/ARGENT
4 014970 131417
9200-7011 / VE 12
WEISS/WHITE/BLANC
4 014970 131424

F  9200-1109 / VE 12
GOLD/GOLD/OR
4 014970 131202
9200-1110 / VE 12
SILBER/SILVER/ARGENT
4 014970 131219

F  9200-7100 / VE 12
GOLD/GOLD/OR
4 014970 131585
9200-7101 / VE 12
SILBER/SILVER/ARGENT
4 014970 131592

Peel-Off Stickers

ORDNEN MIT STIL S.O.H.O.



S.O.H.O. ORDNER MIT STIL

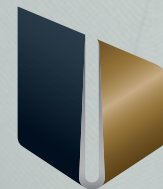

german
brand
award
21
winner

S.O.H.O. ORDNER MIT STIL

Die Ordnungslinie S.O.H.O. (Smart Office | Home Office) bringt geradliniges Design, Klarheit und Struktur in jedes Büro, Home Office oder Wohnzimmer. S.O.H.O.-Produkte sind praktische Ordnungshelfer und schaffen stilvolles Ambiente.

The S.O.H.O. range (Smart Office | Home Office) brings straightforward design, clarity and structure to any office, home office or living room.

La ligne de rangement S.O.H.O. (Smart Office | Home Office) apporte un design rectiligne, de la clarté et de la structure dans chaque bureau, home-office ou salon.

Passend für jeden Stil: maximale Flexibilität durch große Farbauswahl.

Suitable for every style: maximum flexibility thanks to a wide choice of colours.

Adapté à tous les styles: flexibilité maximale grâce à un grand choix de couleurs.

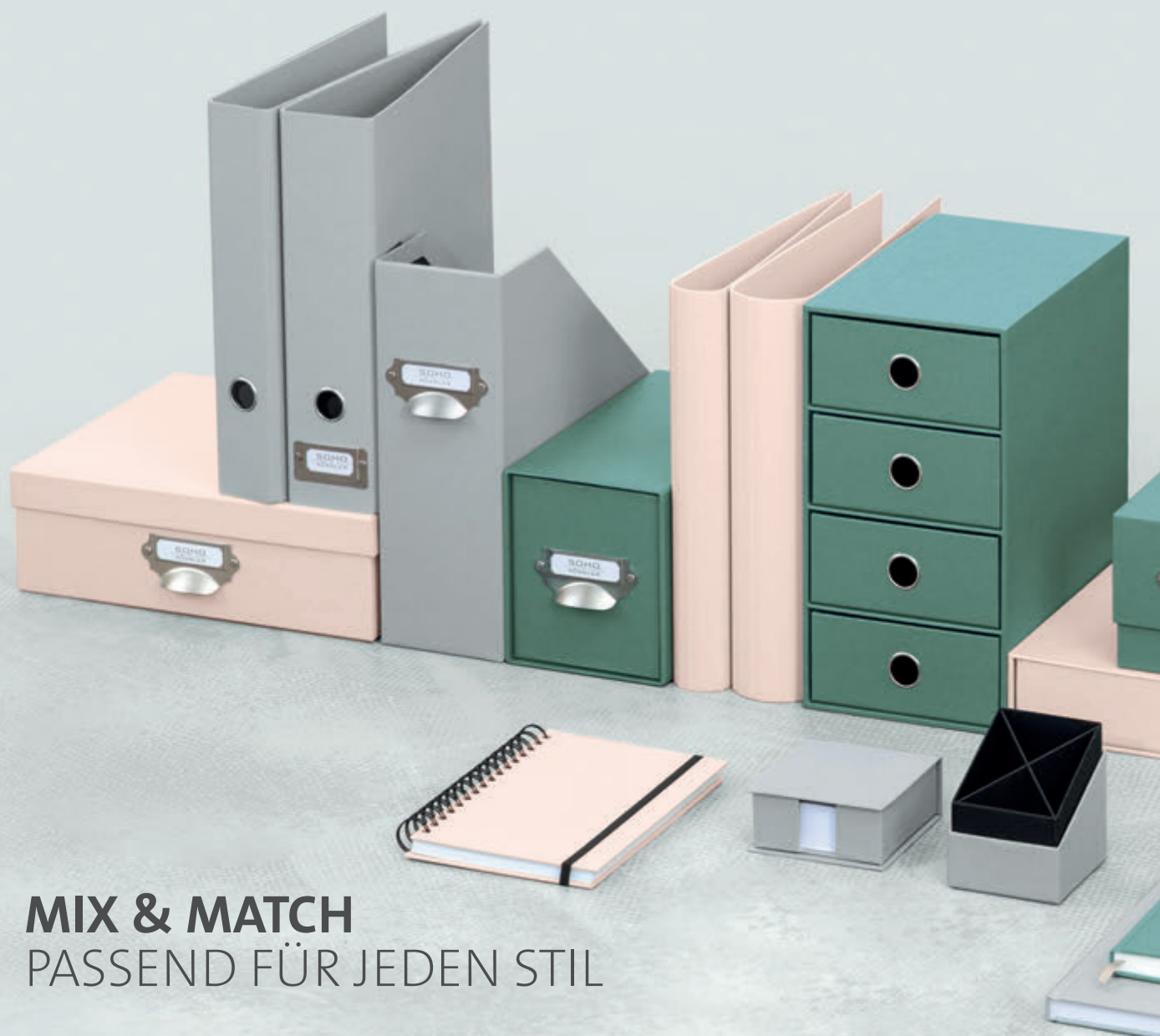

MIX & MATCH
PASSEND FÜR JEDEN STIL

VIelfALT IN FARBE, PRODUKT UND ANWENDUNG

S.O.H.O. setzt stilvolle Designakzente und schafft gleichzeitig Struktur und Klarheit auf Premium-Level. Die große Farbauswahl ermöglicht es, individuelle Farbkonzepte zu erstellen, die perfekt auf den jeweiligen Charakter einer (Büro-) Einrichtung abgestimmt sind.

The large selection of colours makes it possible to create individual colour concepts that perfectly match to the respective character of each (office) interior.

Le grand choix de couleurs permet de créer des concepts de couleurs individuels, parfaitement adaptés au caractère de chaque aménagement (de bureau).



ORDNEN MIT STIL S.O.H.O.



DESIGN MIT WOW-EFFEKT

Das S.O.H.O.-Sortiment überzeugt durch eine einzigartige Kombination aus Design, Qualität und Nachhaltigkeit. Die stilvollen Ordnungsprodukte sind gefragte Gestaltungselemente in der modernen Einrichtung. Ein eleganter Purismus zeichnet die gesamte Produktlinie aus. 2021 wurde das S.O.H.O.-Sortiment mit zwei German Brand Awards prämiert: in den Kategorien „Office & Stationery“ und „Sustainable Brand of the Year“.

The S.O.H.O. range features a unique combination of design, quality and sustainability. An elegant purism characterises the entire product line. In 2021, the S.O.H.O. range won two German Brand Awards: in the categories “Office & Stationery” and “Sustainable Brand of the Year”.

La gamme S.O.H.O. convainc par une combinaison unique de design, de qualité et de durabilité. Un purisme élégant caractérise l'ensemble de la ligne de produits. En 2021, la gamme S.O.H.O. a été récompensée par deux German Brand Awards : dans les catégories „Office & Stationery“ et “Sustainable Brand of the Year”.





QUALITÄT ZUM ANFASSEN

S.O.H.O.-Produkte sind hochwertig – vom Material über die Verarbeitung bis hin zum Design. Die Qualität ist schon beim ersten Anfassen zu spüren: Natürliche, strukturierte Bezugsmaterialien bieten eine faszinierende Haptik und schaffen eine warme, natürliche Atmosphäre.

S.O.H.O. products are high-quality – from the material to the workmanship to the design. Natural, structured cover materials offer a fascinating feel.

Les produits S.O.H.O. sont de grande qualité – du matériau au design en passant par la finition. Les matériaux de revêtement naturels et structurés offrent un toucher fascinant.



ORDNEN MIT STIL S.O.H.O. CLASSIC RIB





Der Klassiker:

Das Bezugsmaterial mit feiner Rippung hat eine zeitlos-edle Optik und unterstreicht das geradlinige und elegante Design der S.O.H.O.-Linie.

S.O.H.O. CLASSIC RIB

A classic: The cover material with fine ribbing has a timelessly elegant look and underlines the straightforward and elegant design of the S.O.H.O. range.

Le classique: Le matériau de revêtement avec ses fines nervures a un aspect noble et intemporel et souligne le design rectiligne et élégant de la ligne S.O.H.O.

ORDNEN MIT STIL S.O.H.O. CLASSIC RIB

Exklusive Ordnungs-
produkte in großer
Farbvielfalt.

An exclusive range of
storage products in a wide
range of colours.

Une sélection d'articles de
classement dans une grande
variété de couleurs.



1317 452 ..0 / VE 4
für DIN A4
85 mm Rückenbreite ·
spine · largeur du dos



1317 452 ..1* / VE 4
für DIN A4
50 mm Rückenbreite ·
spine · largeur du dos



1317 452 ..8* / VE 4
für DIN A4
80 mm Rückenbreite · spine · largeur du dos



1317 452 ..9* / VE 4
für DIN A4
85 mm Rückenbreite · spine · largeur du dos



1318 452 ..0 / VE 3
für DIN A4
85 mm Rückenbreite · spine · largeur du dos



1318 452 ..1 / VE 2
für DIN A4
115 mm Rückenbreite · spine · largeur du dos

* nicht erhältlich in White
not available in white · pas disponible en blanc

S.O.H.O. CLASSIC RIB ORDNER MIT STIL

- 09 White
- 15 Denim
- 17 Stone
- 36 Rot
- 38 Opal
- 49 Taupe
- 58 Powder
- 65 Mint
- 70 Schwarz
- 90 Navy



1316 452 ..0* / VE 3 für DIN A4 · 2 Ring
Füllhöhe · spine · hauteur 25 mm



1316 452 ..5* / VE 3 für DIN A4 · 4 Ring
Füllhöhe · spine · hauteur 50 mm



1875 452 ..1* / VE 5 DIN A5 / 160 Seiten · pages · pages



1312 452 ..0 / VE 4 110 x 110 x 47 mm



1331 452 ..0 / VE 4 86 x 86 x 100 mm

Bezug mit Rippen-Prägung · ribbed cover material · texture cannelée



1878 452 ..2* / VE 3 DIN A4 / 192 Seiten · pages · pages
Blanko · blank · blanc



1882 452 ..1* / VE 3 DIN A5 / 192 Seiten · pages · pages, Offwhite
Punkt kariert · dotted grid · grille en pointillés

* nicht erhältlich in White
not available in white · pas disponible en blanc

ORDNEN MIT STIL S.O.H.O. CLASSIC RIB

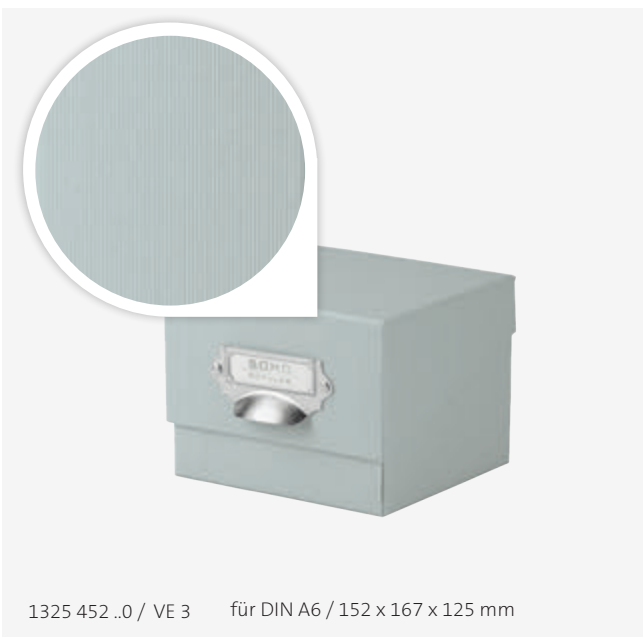
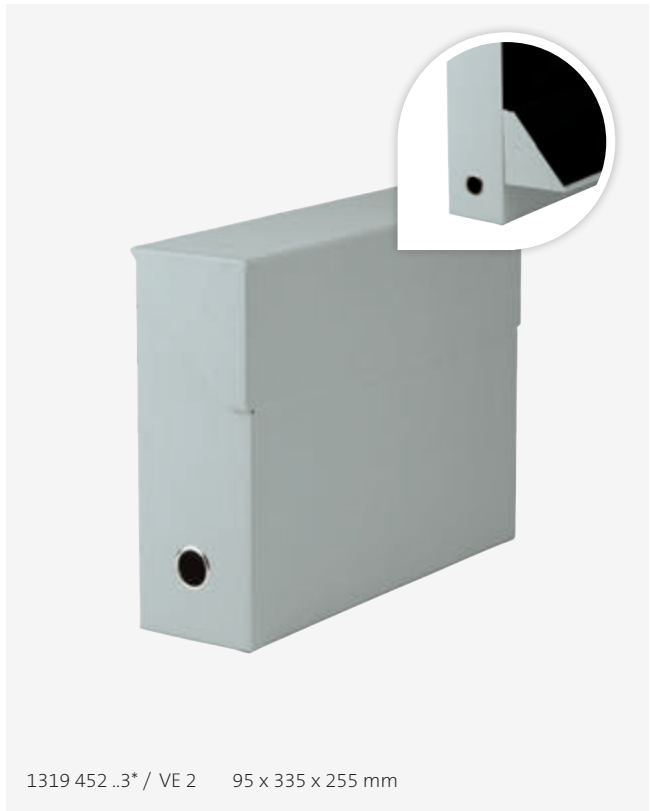
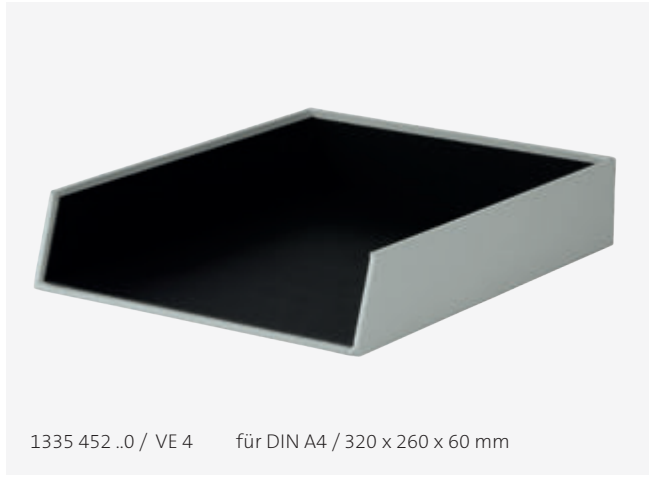

* nicht erhältlich in White
not available in white - pas disponible en blanc

S.O.H.O. CLASSIC RIB ORDNER MIT STIL

- 09 White
- 15 Denim
- 17 Stone
- 36 Rot
- 38 Opal
- 49 Taupe
- 58 Powder
- 65 Mint
- 70 Schwarz
- 90 Navy

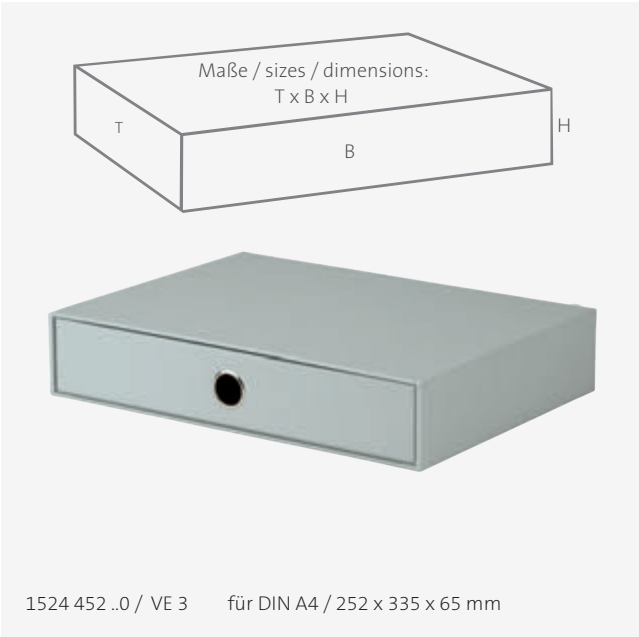

Bezug mit Rippen-Prägung · ribbed cover material · texture cannelée



DOPPELTE AUSZEICHNUNG

in den Kategorien
„Office & Stationery“
und „Sustainable Brand
of the Year“



ORDNEN MIT STIL S.O.H.O. NATURAL LINE





Natur zum Anfassen:
Einzigartige Natur- und Recyclingpapiere. Die
feinen Fasereinschlüsse schaffen eine besonders
attraktive und natürliche Optik.

S.O.H.O. NATURAL LINE

Nature to touch: Unique natural and recycled papers. The fine fibre inclusions create a particularly attractive and natural look.

La nature à portée de main: Des papiers naturels et recyclés uniques en leur genre. Les fines inclusions de fibres créent un aspect particulièrement attrayant et naturel.

ORDNEN MIT STIL S.O.H.O. NATURAL LINE

85 mm Rückenbreite ·
spine · largeur du dos
für DIN A4



1317 452 620 / VE 4



4 014970 092251

1317 452 390 / VE 4



4 014970 435645

85 mm Rückenbreite ·
spine · largeur du dos
für DIN A4



1317 452 629 / VE 4



4 014970 092282

1317 452 399 / VE 4



4 014970 435652

85 mm Rückenbreite ·
spine · largeur du dos
für DIN A4



1318 452 620 / VE 3



4 014970 092299

1318 452 390 / VE 3



4 014970 435669

115 mm Rückenbreite ·
spine · largeur du dos
für DIN A4



1318 452 621 / VE 2



4 014970 092305

1318 452 391 / VE 2



4 014970 435676

für DIN A4 / 250 x 343 x 185 mm



1524 452 623 / VE 1



4 014970 092459

1524 452 393 / VE 1



4 014970 435805

für DIN A4 / 252 x 335 x 65 mm

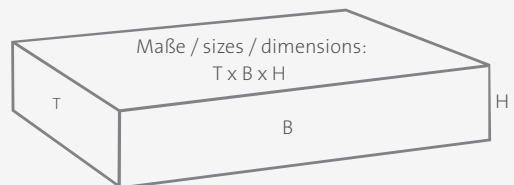

1524 452 620 / VE 3



4 014970 092442

1524 452 390 / VE 3



4 014970 435799

39 Cacao

62 Kraft

für DIN A4 / 320 x 260 x 60 mm



1335 452 620 / VE 4



4 014970 092398

1335 452 390 / VE 4



4 014970 435775

110 x 110 x 47 mm



1312 452 620 / VE 4



4 014970 092220

1312 452 390 / VE 4



4 014970 435638

für DIN A6 / 152 x 167 x 125 mm



1325 452 620 / VE 3



4 014970 092329

1325 452 390 / VE 3



4 014970 435744

86 x 86 x 100 mm



1331 452 620 / VE 4



4 014970 092381

1331 452 390 / VE 4



4 014970 435768

250 x 175 x 320 mm



1524 452 624 / VE 2



4 014970 092466

1524 452 394 / VE 2



4 014970 435812

261 x 143 x 158 mm



1327 452 620 / VE 2



4 014970 092343

1327 452 390 / VE 2



4 014970 435751

255 x 337 x 105 mm



1343 452 620 / VE 2



4 014970 092411

1343 452 390 / VE 2



4 014970 435782

ORDNEN MIT STIL S.O.H.O. SPECIAL LINE





Faszinierende Struktur:

Das einzigartige, elegante Bezugsmaterial in Sisal-Optik begeistert mit einer stoffähnlichen Haptik und sehr hohen Strapazierfähigkeit.

S.O.H.O. SPECIAL LINE

Fascinating structure: The unique, elegant cover material in sisal look inspires with a fabric-like feel and very high durability.

Une structure fascinante: Le matériau de revêtement unique et élégant à l'aspect sisal séduit par son toucher semblable à celui d'un tissu et sa très grande résistance.

ORDNEN MIT STIL S.O.H.O. SPECIAL LINE

85 mm Rückenbreite ·
spine · largeur du dos
für DIN A4



1317 452 600 / VE 4



1317 452 670 / VE 4



85 mm Rückenbreite ·
spine · largeur du dos
für DIN A4



1317 452 609 / VE 4



1317 452 679 / VE 4



85 mm Rückenbreite ·
spine · largeur du dos
für DIN A4



1318 452 600 / VE 3



1318 452 670 / VE 3



115 mm Rückenbreite ·
spine · largeur du dos
für DIN A4



1318 452 601 / VE 2



1318 452 671 / VE 2



für DIN A4 / 250 x 343 x 185 mm



1524 452 603 / VE 1



1524 452 673 / VE 1



für DIN A4 / 252 x 335 x 65 mm

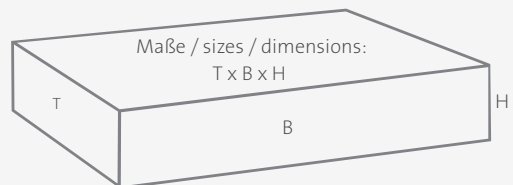

1524 452 600 / VE 3



1524 452 670 / VE 3



S.O.H.O. SPECIAL LINE ORDNER MIT STIL

60 Hazelnut

67 Sage

250 x 175 x 320 mm



1524 452 604 / VE 2



4 014970 375781

1524 452 674 / VE 2



4 014970 375811

261 x 143 x 158 mm



1327 452 600 / VE 2



4 014970 437755

1327 452 670 / VE 2



4 014970 437748

255 x 337 x 105 mm



1343 452 600 / VE 2



4 014970 375644

1343 452 670 / VE 2



4 014970 375651

für DIN A6 / 152 x 167 x 125 mm



1325 452 600 / VE 3



4 014970 375583

1325 452 670 / VE 3



4 014970 375590

86 x 86 x 100 mm



1331 452 600 / VE 4



4 014970 375606

1331 452 670 / VE 4



4 014970 375613

für DIN A4 / 320 x 260 x 60 mm

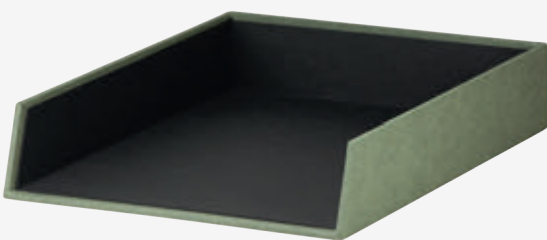

1335 452 600 / VE 4



4 014970 375620

1335 452 670 / VE 4



4 014970 375637

110 x 110 x 47 mm



1312 452 600 / VE 4



4 014970 375484

1312 452 670 / VE 4



4 014970 375491

ORDNEN MIT STIL S.O.H.O. FARBEN & BESTELLFORMULAR

COLOURS · COULEURS

S.O.H.O. CLASSIC RIB FARBEN · COLOURS · COULEURS



Bitte ergänzen Sie die gewünschte Farbnummer.
Please add colour code. · Ajoutez code couleur.

ART.-NR. Ref No Référence	BEZEICHNUNG Description Désignation	VE Unit U/vente	Farbnummer	15	17	36	38	49	58	65	70	90	09
			Colour · Couleur	Denim	Stone	Rot	Opal	Taupe	Powder	Mint	Schwarz	Navy	White
1312 452..0	ZETTELKASTEN, 110 x 110 x 47 mm jotterbox · cube distributeur de papier	4											
1316 452..0	RINGBUCH (2), für · for · pour DIN A4, 25 mm Füllhöhe · spine · hauteur ringbinder · classeur anneaux	3											
1316 452..5	RINGBUCH (4), für · for · pour DIN A4, 50 mm Füllhöhe · spine · hauteur ringbinder · classeur anneaux	3											
1317 452..0	ORDNER MIT HEBELMECHANIK, Rückenbreite · spine · largeur du dos 85 mm file · classeur à levier	4											
1317 452..1	ORDNER MIT HEBELMECHANIK, Rückenbreite · spine · largeur du dos 50 mm file · classeur à levier	4											
1317 452..8	ORDNER MIT HEBELMECHANIK UND METALL-LABELHALTER Rückenbreite · spine · largeur du dos 80 mm · file · classeur à levier	4											
1317 452..9	ORDNER MIT HEBELMECHANIK UND PP-RÜCKENSCHILD Rückenbreite · spine · largeur du dos 85 mm · file · classeur à levier	4											
1318 452..0	STEHSAMMLER, Rückenbreite · spine · largeur du dos 80 mm für · for · pour DIN A4 · magazine holder · boîte d'archives	3											
1318 452..1	STEHSAMMLER MIT GRIFF, Rückenbreite · spine · largeur du dos 115 mm für · for · pour DIN A4 · magazine holder · boîte d'archives	2											
1319 452..3	ARCHIVBOX, 95 x 335 x 255 mm storage box · boîte transfert	2											
1325 452..0	FOTOKISTE, 152 x 167 x 125 mm, auch für Karteikarten DIN A6 photobox · boîte pour photos	3											
1327 452..0	CD-SCHUBLADENBOX MIT GRIFF, 261 x 143 x 158 mm CD box with label · boîte de CD avec poignée	2											
1331 452..0	STIFTEKÖCHER, 86 x 86 x 100 mm pencil box · pot à crayons	4											
1335 452..0	ABLAGEKORB (STAPELBAR), 320 x 260 x 60 mm, für · for · pour DIN A4 filling tray · corbeille courrier	4											
1343 452..0	AUFBEWAHRUNGSKARTONAGE MIT GRIFF, 255 x 337 x 105 mm, box · boîte	2											
1524 452..0	SCHUBLADENBOX, 252 x 335 x 65 mm, für · for · pour DIN A4 carton drawer · boîte d'archives coulissante	3											
1524 452..3	3ER SCHUBLADENBOX, 250 x 343 x 185 mm, für · for · pour DIN A4 carton drawer (3) · boîte d'archives coulissante (3)	1											
1524 452..4	4ER SCHUBLADENBOX, 250 x 175 x 320 mm carton drawer (4) · boîte d'archives coulissante (4)	2											
1529 452..2	SAMMELMAPPE, für · for · pour DIN A4 folder · chemise	5											
1875 452..1	WIRE-O-NOTIZBUCH MIT GUMMIZUG, für · for · pour DIN A5, 160 Seiten · pages · pages wire-o-notebook with elastic · carnet de notes à spirales avec bande élastique	5											
1878 452..2	GEBUNDENES NOTIZBUCH DIN A4, 192 Seiten · pages · pages bound notebook · carnet de notes	3											
1882 452..1	GEBUNDENES NOTIZBUCH DIN A5, 192 Seiten · pages · pages bound notebook · carnet de notes · dotted grid	3											

Das S.O.H.O.-Sortiment bietet eine große Farbauswahl, die es ermöglicht, individuelle Farbwelten zu schaffen. Die zertifizierten Bezugsmaterialien werden in Europa produziert.

The S.O.H.O. range offers a wide range of colours, which makes it possible to create individual colour worlds. The certified cover materials are produced in Europe.

La gamme S.O.H.O. offre un grand choix de couleurs, ce qui permet de créer des univers de couleurs personnalisés. Les matériaux de revêtement certifiés sont produits en Europe.

S.O.H.O. SPECIAL LINE
FARBEN · COLOURS · COULEURS



S.O.H.O. NATURAL LINE
FARBEN · COLOURS · COULEURS

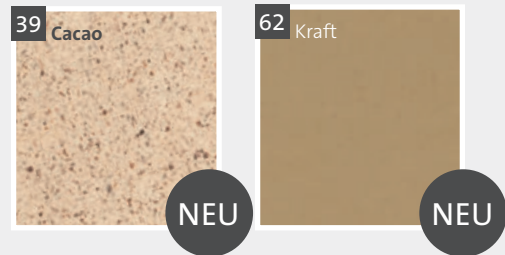

Bitte ergänzen Sie die gewünschte Farbnummer.
Please add colour code. · Ajoutez code couleur.

ART.-NR. Ref No Référence	BEZEICHNUNG Description Désignation	Farbnummer Colour · Couleur				
			60 Hazelnut	67 Sage	39 Cacao	62 Kraft
1312 452 . . 0	ZETTELKASTEN, 110 x 110 x 47 mm jotterbox · cube distributeur de papier	VE Unit U/vente				
1317 452 . . 0	ORDNER MIT HEBELMECHANIK, Rückenbreite · spine · largeur du dos 85 mm file · classeur à levier	4				
1317 452 . . 9	ORDNER MIT HEBELMECHANIK UND PP-RÜCKENSCHILD Rückenbreite · spine · largeur du dos 85 mm · file · classeur à levier	4				
1318 452 . . 0	STEHSAMMLER, Rückenbreite · spine · largeur du dos 80 mm für · for · pour DIN A4 · magazine holder · boîte d'archives	3				
1318 452 . . 1	STEHSAMMLER MIT GRIFF, Rückenbreite · spine · largeur du dos 115 mm für · for · pour DIN A4 · magazine holder · boîte d'archives	2				
1325 452 . . 0	FOTOKISTE, 152 x 167 x 125 mm, auch für Karteikarten DIN A6 photobox · boîte pour photos	3				
1327 452 . . 0	CD-SCHUBLADENBOX MIT GRIFF, 261 x 143 x 158 mm CD box with label · boîte de CD avec poignée	2				
1331 452 . . 0	STIFTEKÖCHER, 86 x 86 x 100 mm pencil box · pot à crayons	4				
1335 452 . . 0	ABLAGEKORB (STAPELBAR), 320 x 260 x 60 mm, für · for · pour DIN A4 filling tray · corbeille courrier	4				
1343 452 . . 0	AUFBEWAHRUNGSKARTONAGE MIT GRIFF, 255 x 337 x 105 mm, box · boîte	2				
1524 452 . . 0	SCHUBLADENBOX, 252 x 335 x 65 mm, für · for · pour DIN A4 carton drawer · boîte d'archives coulissante	3				
1524 452 . . 3	3ER SCHUBLADENBOX, 250 x 343 x 185 mm, für · for · pour DIN A4 carton drawer (3) · boîte d'archives coulissante (3)	1				
1524 452 . . 4	4ER SCHUBLADENBOX, 250 x 175 x 320 mm carton drawer (4) · boîte d'archives coulissante (4)	2				

Farbabweichungen zwischen Druck und Original sind möglich.
Slight deviations in colour between print and original cannot be excluded.
Des différences minimales de couleur entre l'impression et l'original ne peuvent pas être exclues.



PAPETERIE SCHREIBEN & LEBEN

Papeterie-Kollektionen von Rössler lassen die Herzen von Papierliebhabern höher schlagen. Stilvolle Designs, hochwertige Materialien und charmante Details zeichnen die beliebten Papeterie-Kollektionen aus. Qualitätsprodukte, die Freude schenken!

Rössler stationery collections are characterized by elegant designs, high-quality materials and charming details.

Les collections de papeterie se caractérisent par des designs élégants, des matériaux de haute qualité et des détails charmants.

PAPETERIE WIESENBLUMEN

AUS NATURPAPIER
 Made from natural paper
 En papier naturel



1317 1960 000 / VE 4



4 014970 429439

für · for · pour DIN A4
 85 mm Rückenbreite · spine · largeur du dos



1318 1960 000 / VE 3



4 014970 429446

für · for · pour DIN A4
 80 mm Rückenbreite · spine · largeur du dos



1316 1960 003 / VE 4



4 014970 429422

für · for · pour DIN A5



1874 1960 001 / VE 3



4 014970 429576

DIN A5 / 160 Seiten · pages · pages
 offwhite, blanco

DIN A5 / 192 Seiten · pages · pages
 offwhite, blanco



1882 1960 001 / VE 3



4 014970 429590

80 x 200 mm / 50 bedruckte Blätter
 printed sheets · feuilles imprimées
 mit Magnet



1310 1960 100 / VE 4



4 014970 429415

4/4, B6 hd/B6
 auch im Display 1880 1960 991



1182 19 1960 / VE 4*



4 014970 431197



* 8x im Display
1880 1960 991 / VE 1



Wochenplaner
148 x 210 mm / 60 bedruckte Blätter
printed sheets · feuilles imprimées



1216 1960 000 / VE 4*



105 x 210 mm / 60 bedruckte Blätter
printed sheets · feuilles imprimées



1310 1960 000 / VE 4*



115 x 200 mm / 60 bedruckte Blätter
printed sheets · feuilles imprimées

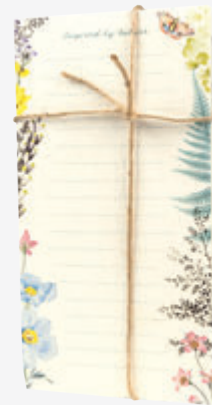

1217 1960 004 / VE 4*



DIN A5 / 48 Seiten · pages · pages
Punktkariert · dotted grid · grille en pointillés



1880 1960 201 / VE 5*



DIN A5 / 48 Seiten · pages · pages
Punktkariert · dotted grid · grille en pointillés



1880 1960 101 / VE 5*



Notizheft Display
DIN A5 / 48 Seiten · pages · pages
Punktkariert · dotted grid · grille en pointillés
2 x 10 sortiert · assorted · assorties



1880 1960 888 / VE 20



PAPETERIE WIESENBLUMEN

5/5, DIN A4/ DL



1134 1960 800 / VE 5



4 014970 429392

DIN A4



1643 1960 800 / VE 50



4 014970 429552



1173 1960 000 / VE 5



4 014970 429408

10/10, 185 x 250 mm / FT. 7



1877 1960 006 / VE 2



4 014970 429583

230 x 220 mm
60 Seiten · pages · pages / offwhite

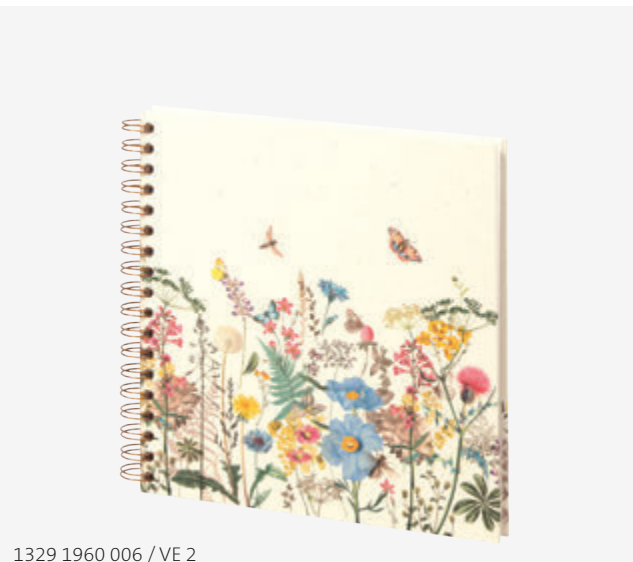

1329 1960 006 / VE 2



4 014970 429477

230 x 230 mm
60 Seiten · pages · pages / offwhite



1332 1960 000 / VE 4



4 014970 429484

Tischset zum Abreißen
12 Blätter geblockt · sheets · feuilles, 240 g/m²
400 x 300 mm



1456 1960 002 / VE 2



4 014970 429545

für · for · pour DIN A4
335 x 225 x 50 mm



1405 1960 000 / VE 15



15x in Dekor-Box
pro Rolle 2 Bogen
500 x 700 mm



1401 1960 000 / VE 15



500 x 700 mm



1647 1960 000 / VE 12



12 x DL/DL mit Einlegekarte



170 x 125 x 50 mm
220 x 159 x 65 mm
240 x 200 x 90 mm
285 x 238 x 110 mm

1343 1960 004 / VE 1



1368 1960 000 / VE 8



230 x 230 x 85 mm

IDEAL KOMBINIERBAR MIT

Ideal to combine with

Idéal à combiner avec



PAPETERIE GRAS



1317 1961 000 / VE 4



für · for · pour DIN A4
85 mm Rückenbreite · spine · largeur du dos



1318 1961 001 / VE 2



für · for · pour DIN A4
115 mm Rückenbreite · spine · largeur du dos



1210 1961 000 / VE 5



DIN A4, 40 Blätter · sheets · feuilles
Heißfolie Schwarz · hot foil · avec impression

HEISSFOLIE
SCHWARZ
Hot foil
Impression



1211 1961 001 / VE 5



DIN A5, 40 Blätter · sheets · feuilles
Heißfolie Schwarz · hot foil · avec impression

GRASPAPIER · GRASS PAPER · PAPIER D'HERBE

Dieses edle Naturpapier hat einen Grasanteil von bis zu 30%. Das Gras wird sonnengetrocknet und der Papierproduktion ohne Behandlung durch Chemikalien zugegeben. So verfügt das Graspapier über eine besonders natürliche Optik mit feinen Fasereinschlüssen und ist besonders weich und angenehm anzufassen.

This noble natural paper has a grass content of up to 30%. The grass is sun-dried and added to the paper production without treatment with chemicals.

Ce papier naturel noble contient jusqu'à 30% d'herbe. L'herbe est séchée au soleil et ajoutée à la production de papier sans traitement par des produits chimiques.



PAPETERIE TILLY

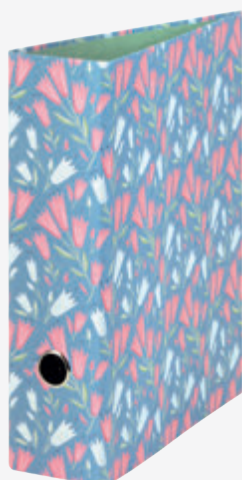

1317 1955 000 / VE 4



4 014970 429095

für · for · pour DIN A4
85 mm Rückenbreite · spine · largeur du dos



1318 1955 000 / VE 3



4 014970 429101

für · for · pour DIN A4
80 mm Rückenbreite · spine · largeur du dos



1316 1955 000 / VE 4



4 014970 429057

für · for · pour DIN A4



1316 1955 003 / VE 4



4 014970 429040

für · for · pour DIN A5



1882 1955 001 / VE 3



4 014970 429217

DIN A5/ 192 Seiten · pages · pages
weiß, blanco



1874 1955 001 / VE 3



4 014970 429194

DIN A5/ 160 Seiten · pages · pages
weiß, blanco



1880 1955 991 / VE 20



DIN A5 / 48 Seiten · pages · pages
 Punktkariert · dotted grid · grille en pointillés
 2 x 10 sortiert · assorted · assorties



1173 1955 000 / VE 5



10/10, 185 x 250 mm / FT. 7

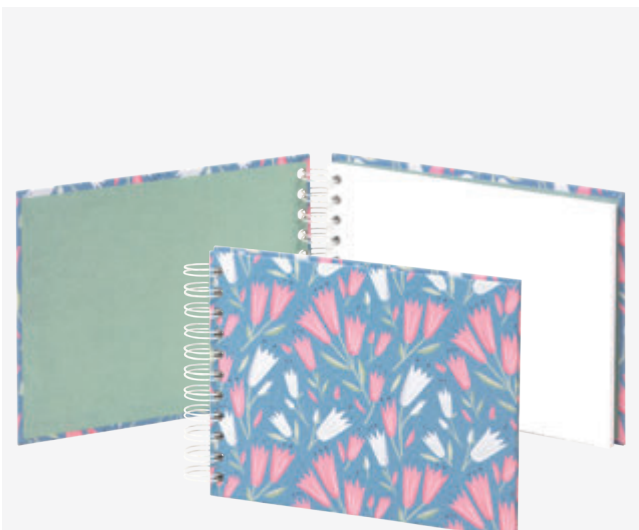

1329 1955 000 / VE 3



195 x 145 mm
 40 Seiten · pages · pages / weiß

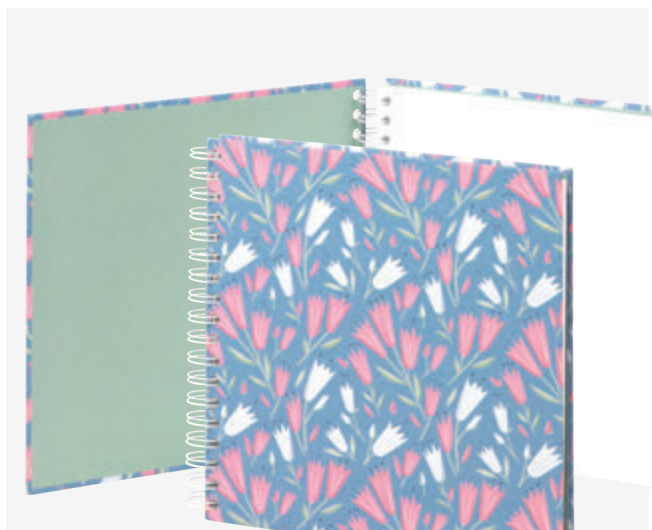

1329 1955 006 / VE 2



230 x 230 mm
 60 Seiten · pages · pages / weiß

IDEAL KOMBINIERBAR MIT

Ideal to combine with
 Idéal à combiner avec



PAPETERIE TILLY



1365 1955 000 / VE 8



4 014970 429163

190 x 260 x 80 mm



1366 1955 000 / VE 8



4 014970 429170

110 x 150 x 65 mm

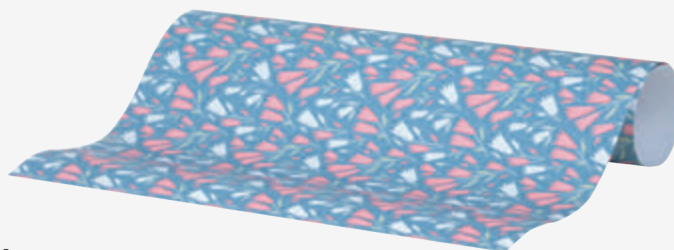

1401 1955 000 / VE 15



4 014970 429187

500 x 700 mm

7ER SATZ Boxline
 96 x 128 x 40 mm
 121 x 162 x 50 mm
 140 x 190 x 60 mm
 170 x 230 x 70 mm
 196 x 264 x 80 mm
 221 x 298 x 90 mm
 248 x 329 x 100 mm



1341 1453 580 / VE 1



4 014970 381911

170 x 125 x 50 mm
 220 x 159 x 65 mm
 240 x 200 x 90 mm
 285 x 238 x 110 mm



1343 1955 004 / VE 1



4 014970 429118



1317 1956 000 / VE 4



für · for · pour DIN A4
85 mm Rückenbreite · spine · largeur du dos



1318 1956 000 / VE 3



für · for · pour DIN A4
80 mm Rückenbreite · spine · largeur du dos



1883 1956 991 / VE 1



DIN A5 / 2 x 5 sortiert · assorted · assorties
Punkt kariert · dotted grid · grille en pointillés
Heißfolie Gold · hot foil · avec impression

HEISSFOLIE
GOLD
Hot foil
Impression



„Oh happy day“
1883 1956 101 / VE 3



„Mein Gedankensammler“
1883 1956 201 / VE 3



PAPETERIE TILLY GREEN



HEISSFOLIE
GOLD
Hot foil
Impression

1329 1956 000 / VE 3



195 x 145 mm
40 Seiten · pages · pages / offwhite



1329 1956 006 / VE 2



230 x 230 mm
60 Seiten · pages · pages / offwhite



HEISSFOLIE
GOLD
Hot foil
Impression

1329 1956 800 / VE 2



Geburtstagskalender
12 bedruckte Blätter
printed sheets · feuilles imprimées

- 96 x 128 x 40 mm
- 121 x 162 x 50 mm
- 140 x 190 x 60 mm
- 170 x 230 x 70 mm
- 196 x 264 x 80 mm
- 221 x 298 x 90 mm
- 248 x 329 x 100 mm



HEISSFOLIE
GOLD
Hot foil
Impression

1347 1956 006 / VE 4



(2+2)
126 x 96 x 40 mm
Heißfolie Gold · hot foil · avec impression

1341 1956 000 / VE 1





1317 1964 000 / VE 4

4 014970 430046

für · for · pour DIN A4
85 mm Rückenbreite · spine · largeur du dos



1318 1964 000 / VE 3

4 014970 430053

für · for · pour DIN A4
80 mm Rückenbreite · spine · largeur du dos

für · for · pour DIN A5



1316 1964 003 / VE 4

4 014970 430039

DIN A5/ 192 Seiten · pages · pages
offwhite, blanco



1882 1964 001 / VE 3

4 014970 429873

230 x 220 mm
60 Seiten · pages · pages / offwhite



1877 1964 006 / VE 2

4 014970 429866



1182 06 1964 / VE 4

4 014970 429996

4/4, A6 hd/C6, ivory gerippt
Heißfolie Schwarz · hot foil · avec impression

HEISSFOLIE
SCHWARZ
Hot foil
Impression



1182 06 1963 / VE 4

4 014970 431814

4/4, A6 hd/C6, ivory gerippt
Heißfolie Schwarz · hot foil · avec impression

PAPETERIE BOTANICALS



1026 1964 000 / VE 3



20/20, DIN A5/ C6 mit bedrucktem Seidenfutter
ivory gerippt



1173 1964 000 / VE 5



10/10, 185 x 250 mm / FT. 7

5/5, DIN A4/ DL



1134 1964 800 / VE 5



DIN A4



1643 1964 800 / VE 50

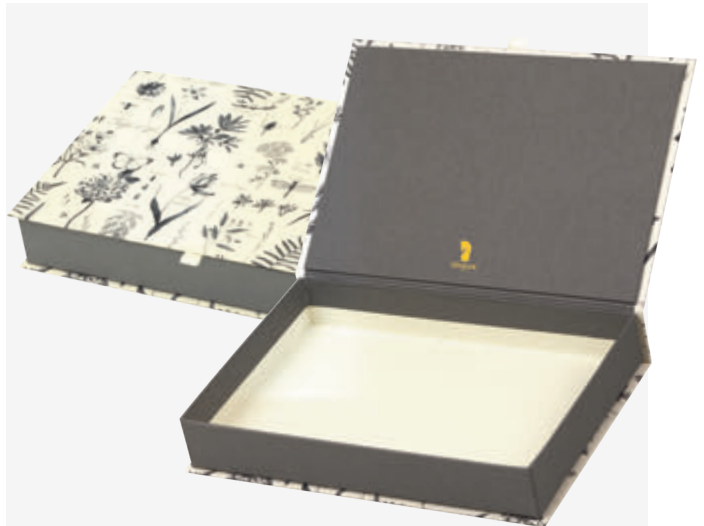

1456 1964 002 / VE 2



für · for · pour DIN A4
335 x 225 x 50 mm

IDEAL KOMBINIERBAR MIT

Ideal to combine with
Idéal à combiner avec



BOTANICALS & DARK GREY PAPETERIE



PAPETERIE LAVENDEL



1317 1958 000 / VE 4



für · for · pour DIN A4
85 mm Rückenbreite · spine · largeur du dos



1318 1958 001 / VE 2



für · for · pour DIN A4
115 mm Rückenbreite · spine · largeur du dos



1877 1958 006 / VE 2



„Wunderbare Momente“
230 x 220 mm
60 Seiten · pages · pages / offwhite



1329 1958 800 / VE 2



Geburtskalender
12 bedruckte Blätter
printed sheets · feuilles imprimées



1329 1958 000 / VE 3



„Every Photo tells a Story“
195 x 145 mm
40 Seiten · pages · pages / offwhite



1329 1958 006 / VE 2



„Every Photo tells a Story“
230 x 230 mm
60 Seiten · pages · pages / offwhite

96 x 128 x 40 mm
 121 x 162 x 50 mm
 140 x 190 x 60 mm
 170 x 230 x 70 mm
 196 x 264 x 80 mm
 221 x 298 x 90 mm
 248 x 329 x 100 mm



1341 1958 000 / VE 1



4 014970 429712



HEISSFOLIE
 SCHWARZ
 Hot foil
 Impression

1347 1958 006 / VE 4

(2+2)

126 x 96 x 40 mm

Heißfolie Schwarz · hot foil · avec impression



4 014970 429927



HEISSFOLIE
 SCHWARZ
 Hot foil
 Impression

1216 1958 100 / VE 3

Wochenplaner

240 x 135 mm / 52 bedruckte Blätter
 printed sheets · feuilles imprimées



4 014970 430565

DIN A5/ 192 Seiten · pages · pages / offwhite
 Punktkariert · dotted grid · grille en pointillés



„Notes“

1883 1958 101 / VE 3



4 014970 430541



„Dream it, Plan it, Do it“

1883 1958 201 / VE 3



4 014970 429088

HEISSFOLIE
 SCHWARZ
 Hot foil
 Impression



1883 1958 991 / VE 1

DIN A5 / 2 x 5 sortiert · assorted · assorties
 Punktkariert · dotted grid · grille en pointillés
 Heißfolie Schwarz · hot foil · avec impression



4 014970 430510

PAPETERIE SUMMER VIBES



1317 1977 000 / VE 4



4 014970 438011

für · for · pour DIN A4
85 mm Rückenbreite · spine · largeur du dos



1318 1977 000 / VE 3



4 014970 438028

für · for · pour DIN A4
80 mm Rückenbreite · spine · largeur du dos



1316 1977 000 / VE 4



4 014970 437991

für · for · pour DIN A4



1316 1977 003 / VE 4



4 014970 438004

für · for · pour DIN A5



1329 1977 000 / VE 3



4 014970 438035

195 x 145 mm
40 Seiten · pages · pages / weiß



1874 1977 001 / VE 3



4 014970 438127

DIN A5 / 160 Seiten · pages · pages
offwhite, blanco

SUMMER VIBES PAPETERIE



1173 1977 000 / VE 5



10/10, 185 x 250 mm / FT. 7



1368 1977 000 / VE 8



230 x 230 x 85 mm

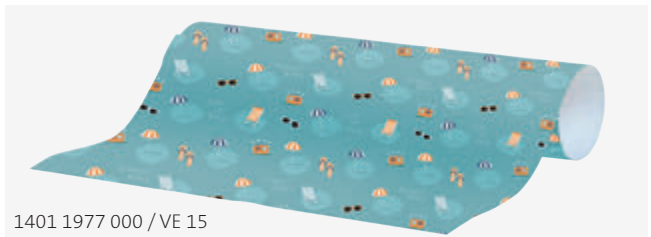

1401 1977 000 / VE 15



500 x 700 mm

95 x 125 x 40 mm
 120 x 160 x 50 mm
 145 x 195 x 60 mm
 170 x 230 x 70 mm
 195 x 265 x 80 mm



1341 1977 005 / VE 1



4 014970 438042

PAPETERIE SUMMER VIBES

Wochenplaner
148 x 210 mm / 60 bedruckte Blätter
printed sheets · feuilles imprimées

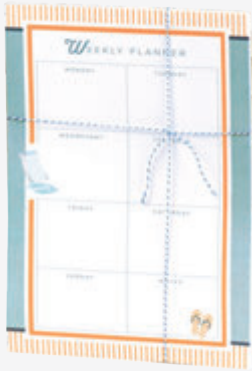

1216 1977 000 / VE 4*



4 014970 437960

115 x 210 mm / 60 bedruckte Blätter
printed sheets · feuilles imprimées



1310 1977 000 / VE 4*



4 014970 437984

115 x 210 mm / 60 bedruckte Blätter
printed sheets · feuilles imprimées



1217 1977 004 / VE 4*



4 014970 437977



1182 19 1977 / VE 4**



4 014970 437939

4/4, B6/B6 Einzelkarte
bedruckt · printed · imprimée



1182 19 1978 / VE 4**



4 014970 437946

4/4, B6/B6 Einzelkarte
bedruckt · printed · imprimée

DIN A5 / 48 Seiten · pages · pages
Punkt kariert · dotted grid · grille en pointillés



1880 1977 101 / VE 5*



4 014970 437861

DIN A5 / 48 Seiten · pages · pages
Punkt kariert · dotted grid · grille en pointillés



1880 1977 201 / VE 5*



4 014970 437878



1880 1977 991 / VE 1



Planning Display
*Jeder der 5 Artikel: 8 x
**Jeder der 2 Artikel: 4 x

PAPETERIE EASY PLANNING

150 x 210 mm / 80 bedruckte Blätter
printed sheets · feuilles imprimées



1216 1951 000 / VE 5



100 x 220 mm / 80 bedruckte Blätter
printed sheets · feuilles imprimées



1310 1951 000 / VE 5



Selbstklebende Haftnotizen



8015 1951 000 / VE 5



150 x 210 mm / 80 bedruckte Blätter
printed sheets · feuilles imprimées



1216 1952 000 / VE 5



100 x 220 mm / 80 bedruckte Blätter
printed sheets · feuilles imprimées



1310 1952 000 / VE 5



Selbstklebende Haftnotizen



8015 1952 000 / VE 5



sortiert · assorted · assorties
Jeder Artikel: 10x

1880 1951 991 / VE 1





PAPETERIE NATURAL LETTERING



1883 3300 001 / VE 3



DIN A5/ 192 Seiten · pages · pages
Punkt kariert · dotted grid · grille en pointillés
Heißfolie Schwarz



1883 3300 101 / VE 3



DIN A5/ 192 Seiten · pages · pages
Punkt kariert · dotted grid · grille en pointillés
Heißfolie Schwarz

Natural Lettering



Naturpapier · natural paper · papier naturel
„Terra Vanilla“



1883 3300 999 / VE 1



DIN A5/ 50 Blatt · sheets · feuilles
Heißfolie Schwarz



1211 3300 001 / VE 5



85 x 180 mm / 50 Blatt · sheets · feuilles
Heißfolie Schwarz



1217 3300 003 / VE 5



200 x 55 x 30 mm, mit Gummizug
Heißfolie Schwarz



1358 3300 000 / VE 4





1883 3301 001 / VE 3



4 014970 399343

DIN A5/ 192 Seiten · pages · pages
Punkt kariert · dotted grid · grille en pointillés
Heißfolie Weiß



1329 3301 000 / VE 3



4 014970 399336

195 x 145 mm / 40 Seiten · pages · pages
Heißfolie Weiß

MAGIC
moments



1883 3301 999 / VE 1



4 014970 399350



1211 3301 001 / VE 5



4 014970 399312

DIN A5/ 50 Blatt · sheets · feuilles
Heißfolie Weiß
Inhaltspapier Schwarz · inside paper black ·
papier de contenu noir



1300 3301 000 / VE 4



4 014970 399329

Für · for · pour 10 x 15 cm
Heißfolie Schwarz

PAPETERIE NOTIZBÜCHER MY JOURNAL



Heißfolie Gold
1883 1881 001 / VE 3



Heißfolie Gold
1883 1882 001 / VE 3



Heißfolie Gold
1883 1883 001 / VE 3



Heißfolie Gold
1883 1884 001 / VE 3



MY JOURNAL

DAS TRENDIGE NOTIZBUCH-SORTIMENT ZUM BULLET PLANNING

DIN A5 · 192 Seiten in Offwhite · punktkariert · mit Anleitung und Vorlagen · mit Einstecktasche
 DIN A5 · 192 pages in offwhite · dotted grid · with instructions and templates · with insert pocket
 DIN A5 · 192 pages en blanc cassé · grille en pointillés · avec instructions et modèles · avec pochette pratique



1883 1880 991 / VE 1



4 x 5 sortiert · assorted · assorties

NOTIZBÜCHER MY JOURNAL PAPETERIE



Heißfolie Gold
1883 1933 001 / VE 3



Heißfolie Gold
1883 1935 001 / VE 3



Heißfolie Gold
1883 1932 001 / VE 3



Heißfolie Gold
1883 1934 001 / VE 3



1883 1932 991 / VE 1



Alle vier Motive außen mit Leinenstruktur
with fabric texture · avec structure en tissu
4 x 5 sortiert · assorted · assorties

1883 1880 991 / VE 1



4 x 5 sortiert · assorted · assorties



Heißfolie Roségold
1883 1431 001 / VE 3



Heißfolie Roségold
1883 1430 001 / VE 3



Heißfolie Roségold
1883 1429 001 / VE 3



Heißfolie Roségold
1883 1880 001 / VE 3



PAPETERIE NOTIZBÜCHER

DIN A5/ 192 Seiten · pages · pages / offwhite
 Punktkariert · dotted grid · grille en pointillés



„Oh happy day“
 1883 1956 101 / VE 3



„Mein Gedankensammler“
 1883 1956 201 / VE 3



HEISSFOLIE
 GOLD
 Hot foil
 Impression



1883 1956 991 / VE 1



DIN A5 / 2 x 5 sortiert · assorted · assorties
 Punktkariert · dotted grid · grille en pointillés
 Heißfolie Gold · hot foil · avec impression

DIN A5/ 192 Seiten · pages · pages / offwhite
 Punktkariert · dotted grid · grille en pointillés



„Notes“
 1883 1958 101 / VE 3



„Dream it, Plan it, Do it“
 1883 1958 201 / VE 3



HEISSFOLIE
 SCHWARZ
 Hot foil
 Impression



1883 1958 991 / VE 1



DIN A5 / 2 x 5 sortiert · assorted · assorties
 Punktkariert · dotted grid · grille en pointillés
 Heißfolie Schwarz · hot foil · avec impression

DIN A5 / 192 Seiten · pages · pages
 weiß, blanco



1882 1955 001 / VE 3



DIN A5 / 192 Seiten · pages · pages
 offwhite, blanco



1882 1960 001 / VE 3



DIN A5 / 192 Seiten · pages · pages
 offwhite, blanco



1882 1964 001 / VE 3





FOTO-NOTIZBÜCHER

Mit Passepartout zum Einstecken eines Fotos (10x15 cm)

With passepartout for inserting a photo (10x15 cm)

Avec passe-partout pour insérer une photo (10x15 cm)

192 Seiten in Offwhite, nummeriert, punktkariert

192 pages in offwhite, numbered, dotted grid

192 pages en blanc cassé, numérotées, quadrillées à points

Mit praktischer Einstecktasche

With practical insert pocket

Avec pochette pratique

1886 3200 151 / VE 3



4 014970 399817



1886 3200 171 / VE 3



4 014970 409103

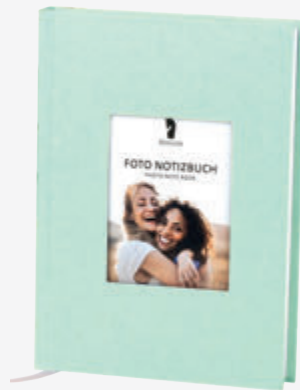

1886 3200 651 / VE 3



4 014970 399831



1886 3200 581 / VE 3



4 014970 399824



1886 3200 491 / VE 3



4 014970 409110



1886 3200 701 / VE 3



4 014970 399848

PAPETERIE NOTIZHEFTE

DIN A5 / 48 Seiten · pages · pages
 Punktkariert · dotted grid · grille en pointillés



1880 1977 101 / VE 5



4 014970 437861

DIN A5 / 48 Seiten · pages · pages
 Punktkariert · dotted grid · grille en pointillés



1880 1977 201 / VE 5



4 014970 437878



1880 1947 991 / VE 20



4 014970 438370

DIN A5 / 48 Seiten · pages · pages
 Punktkariert · dotted grid · grille en pointillés
 2 x 10 sortiert · assorted · assorties

DIN A5 / 48 Seiten · pages · pages
 Punktkariert · dotted grid · grille en pointillés



1880 1947 000 / VE 5



4 014970 422232

DIN A5 / 48 Seiten · pages · pages
 Punktkariert · dotted grid · grille en pointillés

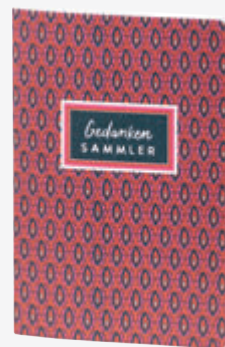

1880 1945 000 / VE 5



4 014970 422249

NOTIZHEFTE PAPETERIE



1880 1955 991 / VE 20



DIN A5 / 48 Seiten · pages · pages
 Punktkariert · dotted grid · grille en pointillés
 2 x 10 sortiert · assorted · assorties



1880 1916 991 / VE 20



DIN A5 / 48 Seiten · pages · pages
 Punktkariert · dotted grid · grille en pointillés
 2 x 10 sortiert · assorted · assorties



1880 1960 888 / VE 20



DIN A5 / 48 Seiten · pages · pages
 Punktkariert · dotted grid · grille en pointillés
 2 x 10 sortiert · assorted · assorties

DIN A5 / 48 Seiten · pages · pages
 Punktkariert · dotted grid · grille en pointillés



1880 1960 201 / VE 5



DIN A5 / 48 Seiten · pages · pages
 Punktkariert · dotted grid · grille en pointillés



1880 1960 101 / VE 5



SCHÖNE FESTE



SCHÖNE FESTE DAS LEBEN FEIERN

Feine Papeterie für die schönsten Momente im Leben! Rössler-Produkte statten jedes Fest stilvoll aus. Die vielseitigen Designs reichen von jung und modisch bis hin zu zeitlos-klassisch. Seidenschleifen und liebevolle Applikationen setzen charmante Akzente.

Fine stationery for the most beautiful moments in life! Rössler products let you furnish every celebration in style.

Une papeterie raffinée pour les plus beaux moments de la vie! Les produits Rössler habillent chaque fête avec style.

DIE SCHÖNSTE
ERINNERUNG



AN EINE
BESONDERE

SCHÖNE FESTE BABY – GIRL

NACHFÜLLBAR
refillable
rechargeable



1877 1928 006 / VE 2



Fotoalbum · photo album · album photo
Mit · with · avec Passepartout
230 x 220 mm / 60 Seiten · pages · pages

Fotoalbum · photo album · album photo
Mit · with · avec Passepartout
245 x 230 mm / 50 Seiten · pages · pages



1316 1928 008 / VE 2



Nachfüllpack · refill pack ·
pack de recharge:
1316 1440 000 / VE 6



1329 1928 900 / VE 3



Fotoaufsteller · photo display ·
porte photos de bureau
190 x 190 mm / 12 Blatt · sheets · feuilles

60 x 87 x 50 mm

1354 1928 000 / VE 4



1329 1928 002 / VE 3



Fotoalbum · photo album · album photo
Mit · with · avec Passepartout
195 x 145 mm / 40 Seiten · pages · pages



1457 1928 001 / VE 3



Fotobox · photo box · boîte photos
Mit · with · avec Passepartout
Magnetverschluss · magnetic closure ·
fermeture magnétique
für · for · pour photos max. 130 x 180 mm



1330 1928 000 / VE 3



Foto-Leporello · photo concertina ·
album photos accordéon
150 x 190 mm



BABY – GIRL SCHÖNE FESTE

215 x 155 x 55 mm



1456 1928 000 / VE 2



4 014970 408908

1401 1929 000 / VE 15



4 014970 414572

500 x 700 mm

1401 1928 000 / VE 15



4 014970 408885

500 x 700 mm

240 x 200 x 90 mm



1343 1928 200 / VE 2



4 014970 409387

190 x 140 x 60 mm



1343 1928 100 / VE 2



4 014970 409370

230 x 190 x 80 mm



1368 1928 000 / VE 8



4 014970 408861

120 x 120 x 60 mm



1366 1928 000 / VE 8



4 014970 411311

1/1, B6 hd/B6



1190 19 1928 / VE 6



4 014970 408748

1190 19 1929 / VE 6



4 014970 408755

1647 1928 999 / VE 10



1647 1928 999 / VE 10



4 014970 408946

sortiert · assorted · assorties
5x DL/DL Baby Girl, 5x DL/DL Baby Boy
mit Einlegekarte · with insert card ·
avec carte à insérer

SCHÖNE FESTE BABY – BOY

NACHFÜLLBAR
refillable
rechargeable



1877 1930 006 / VE 2



Fotoalbum · photo album · album photo
Mit · with · avec Passepartout
230 x 220 mm / 60 Seiten · pages · pages

Fotoalbum · photo album · album photo
Mit · with · avec Passepartout
245 x 230 mm / 50 Seiten · pages · pages



1316 1930 008 / VE 2



Nachfüllpack · refill pack ·
pack de recharge:
1316 1440 000 / VE 6



1329 1930 900 / VE 3



Fotoaufsteller · photo display ·
porte photos de bureau
190 x 190 mm / 12 Blatt · sheets · feuilles

60 x 87 x 50 mm

1354 1930 000 / VE 4



1329 1930 002 / VE 3



Fotoalbum · photo album · album photo
Mit · with · avec Passepartout
195 x 145 mm / 40 Seiten · pages · pages



1457 1930 001 / VE 3



Fotobox · photo box · boîte photos
Mit · with · avec Passepartout
Magnetverschluss · magnetic closure ·
fermeture magnétique
für · for · pour photos max. 130 x 180 mm



1330 1930 000 / VE 3



Foto-Leporello · photo concertina ·
album photos accordéon
150 x 190 mm



BABY – BOY SCHÖNE FESTE

215 x 155 x 55 mm



1456 1930 000 / VE 2



4 014970 408915

240 x 200 x 90 mm



1343 1930 200 / VE 2



4 014970 409899

190 x 140 x 60 mm



1343 1930 100 / VE 2



4 014970 409882

1/1, B6 hd/B6



1190 19 1930 / VE 6



4 014970 408762

1190 19 1931 / VE 6



4 014970 408779

1401 1929 000 / VE 15



4 014970 414572

500 x 700 mm

1401 1930 000 / VE 15



4 014970 408892

500 x 700 mm

230 x 190 x 80 mm



1368 1930 000 / VE 8



4 014970 408878

120 x 120 x 60 mm



1366 1930 000 / VE 8



4 014970 411328

1/1, B6 hd/B6

4 x 8 sortiert · assorted · assorties



1825 19 1928 / VE 1



4 014970 408953

SCHÖNE FESTE KOMMUNION / KONFIRMATION – JOHANNA



1877 6180 006 / VE 2



Fotoalbum · photo album · album photo
Mit · with · avec Passepartout
230 x 220 mm / 60 Seiten · pages · pages / weiß

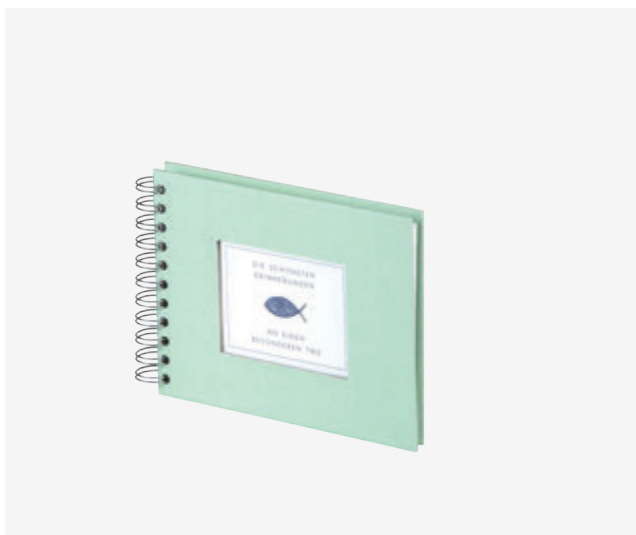

1329 6180 002 / VE 3



Fotoalbum · photo album · album photo
Mit · with · avec Passepartout
195 x 145 mm / 40 Seiten · pages · pages / weiß



1457 6180 001 / VE 3



Fotobox · photo box · boîte photos
Mit · with · avec Passepartout
Magnetverschluss · magnetic closure ·
fermeture magnétique
für · for · pour photos max. 130 x 180 mm



Foto-Leporello · photo concertina ·
album photos accordéon
150 x 190 mm, schwarz
1330 6180 000 / VE 4



10 x DL/DL
2 x 5 sortiert · assorted · assorties

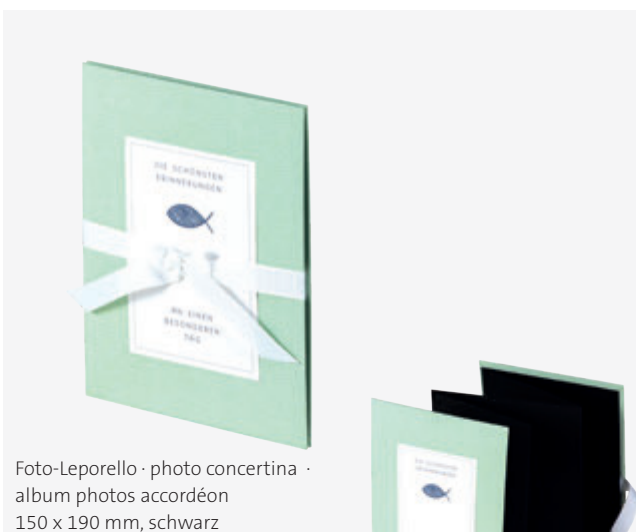

1647 6181 999 / VE 10



JOHANNES – KOMMUNION / KONFIRMATION SCHÖNE FESTE

1/1, B6 hd/B6
2 x 10 sortiert · assorted · assorties



1825 19 6181 / VE 20



1/1, B6 hd/B6
„Beste Wünsche“



1190 19 6180 / VE 6



1/1, B6 hd/B6
„Beste Wünsche“



1190 19 6181 / VE 6



5/5, B6 hd/B6
„Einladung“



1181 6180 100 / VE 5



5/5, B6 hd/B6
„Einladung“



1181 6181 100 / VE 5



Fotoalbum · photo album · album photo
Mit · with · avec Passepartout
230 x 220 mm / 60 Seiten · pages · pages / weiß



1877 6181 006 / VE 2



Fotoalbum · photo album · album photo
Mit · with · avec Passepartout
195 x 145 mm
40 Seiten · pages · pages / weiß



1329 6181 002 / VE 3



Fotobox · photo box · boîte photos
Mit · with · avec Passepartout
Magnetverschluss · magnetic closure · fermeture magnétique
für · for · pour photos max. 130 x 180 mm



1457 6181 001 / VE 3



Foto-Leporello · photo concertina · album photos accordéon
150 x 190 mm, schwarz

1330 6181 000 / VE 4



SCHÖNE FESTE HOCHZEIT – SIMPLY LOVE

95 x 125 x 40 mm
120 x 160 x 50 mm
145 x 195 x 60 mm
170 x 230 x 70 mm



1341 7191 400 / VE 1



Applikation mit Heißfolie Gold
application with hot foil gold
application avec impression d'or

275 x 170 x 50 mm



1451 7191 000 / VE 2



Applikation mit Heißfolie Gold
application with hot foil gold
application avec impression d'or

220 x 230 x 80 mm



1368 7191 000 / VE 6



Applikation mit Heißfolie Gold
application with hot foil gold
application avec impression d'or

130 x 130 x 60 mm



1366 7191 000 / VE 6



500 x 700 mm

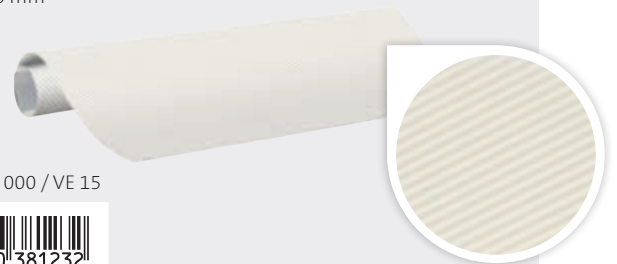

1401 7191 000 / VE 15



4 Tags je Motiv · per motive · par motif

3 x 6 sortiert · assorted · assorties
3 Motive · 6 Päckchen à 4 Tags



1403 7191 999 / VE 1



Heißfolie Gold · hot foil gold ·
avec impression d'or



1403 7191 001 / VE 6



1403 7191 002 / VE 6



1403 7191 003 / VE 6





SCHÖNE FESTE HOCHZEIT – SIMPLY LOVE



1647 7190 000 / VE 5



DL/DL mit Einlegekarte
Applikation mit Heißfolie Gold
with hot foil · avec impression



1647 7190 999 / VE 1



8 x DL/DL mit Einlegekarte
„Mr. & Mrs.“



1647 7191 000 / VE 5



DL/DL mit Einlegekarte
Applikation mit Heißfolie Gold
with hot foil · avec impression



1647 7191 999 / VE 1



8 x DL/DL mit Einlegekarte
„Zur Hochzeit“





1190 19 7193 / VE 8



1/1, B6 hd/B6
Heißfolie Gold - hot foil - avec impression
„Herzlichen Glückwunsch“



1190 19 7194 / VE 8



1/1, B6 hd/B6
Heißfolie Gold - hot foil - avec impression
„Alles Liebe zur Hochzeit“



1190 19 7195 / VE 8



1/1, B6 hd/B6
Heißfolie Gold - hot foil - avec impression
„Mr. & Mrs.“



1190 19 7196 / VE 8



1/1, B6 hd/B6
Heißfolie Gold - hot foil - avec impression
„Herzlichen Glückwunsch zur Hochzeit“

1/1, B6 hd/B6
4 x 8 sortiert - assorted - assorties



1825 19 7191 / VE 1



SCHÖNE FESTE HOCHZEIT – LOVE IS IN THE AIR

95 x 125 x 40 mm
 120 x 160 x 50 mm
 145 x 195 x 60 mm
 170 x 230 x 70 mm



1341 7170 400 / VE 1



4 014970 214103



1877 7170 7176 / VE 2



4 014970 216107

230 x 220 mm
 60 Seiten · pages · pages, weiß · white · blanc

500 x 700 mm



1401 7170 000 / VE 15



4 014970 214158

230 x 190 x 80 mm



1364 7170 000 / VE 6



4 014970 214486



1364 7170 7166 / VE 6



4 014970 214134



1364 7170 7167 / VE 6



4 014970 214141



SCHÖNE FESTE HOCHZEIT – PURE LOVE

205 x 195 x 150 mm



1340 7150 000 / VE 2



Heißfolie Gold · hot foil · avec impression



1877 7150 006 / VE 2



230 x 220 mm
60 Seiten · pages · pages
Heißfolie Gold · hot foil · avec impression

1/1, B6 hd/B6
Heißfolie Gold · hot foil · impression



Crème métallique
mit Rippenprägung

1190 19 7156 / VE 8



1/1, B6 hd/B6
Heißfolie Gold · hot foil · impression



1190 19 7158 / VE 8



205 x 195 x 150 mm

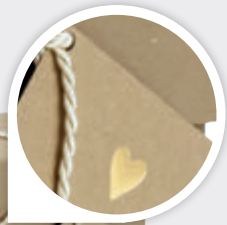

1340 7157 000 / VE 2



Heißfolie Gold · hot foil · avec impression



1877 7157 006 / VE 2



230 x 220 mm
60 Seiten · pages · pages
Heißfolie Gold · hot foil · avec impression



1877 822 005 /VE 2



220 x 180 mm
60 Seiten · pages · pages



1877 822 007 /VE 2



290 x 240 mm
60 Seiten · pages · pages

170 x 320 x 200 mm



WUNDERSCHÖNE SCHLEIFEN

Von Hand gebunden.

Beautiful bows tied manually.

De magnifiques noeuds noués à la main.

1340 822 000 /VE 1



FOTO



FOTO DEN MOMENT FESTHALTEN

Besonderen Erinnerungen einen besonderen Platz geben. Das ist der Anspruch an unser vielfältiges Sortiment rund um das Thema Foto. Wir beraten Sie gerne zu verkaufsfördernden Präsentationsoptionen in Ihrem Geschäft.

Giving special memories a special place – that's the claim we make on our diverse range of photo products.

Donner une place particulière à des souvenirs particuliers – telle est l'ambition de notre assortiment varié sur le thème de la photo.

FOTO RÜCKWAND-PRÄSENTATION

IDEAL ZU INTEGRIEREN IN DEN RÖSSLER-MARKENAUFTRITT

IDEAL FOR INTEGRATION INTO THE RÖSSLER BRAND PRESENCE

IDÉAL À INTÉGRER DANS L'IMAGE DE MARQUE DE RÖSSLER

OPTIMALE PRÄSENTATION MIT LICHT

OPTIMAL PRESENTATION WITH LIGHT

PRÉSENTATION OPTIMALE AVEC LA LUMIÈRE

INNOVATIVE PRODUKTE

INNOVATIVE PRODUCTS

DES PRODUITS INNOVANTS

GROSSE PRODUKTVIELFALT

GREAT PRODUCT DIVERSITY

GRANDE VARIÉTÉ DE PRODUITS

HARMONISCHE FARBEN

HARMONIOUS COLOURS

DES COULEURS HARMONIEUSES



FOTO – DEN MOMENT FESTHALTEN

NEUE RÜCKWAND-PRÄSENTATION
KOMPAKT. AUSDRUCKSSTARK.
ÜBERSICHTLICH.

Diese neue Präsentation bietet unseren beliebten Foto-Bestseller-Produkten einen optimalen Auftritt! Harmonische Farben, individuelle Produkte mit Alleinstellungsmerkmal sowie eine optimal abgestimmte Präsentation mit Licht schaffen einen echten Wow-Effekt. So setzen wir das Thema „Foto“ emotional in Szene.

Unser Vertriebsteam berät Sie gerne!

This new presentation offers our popular photo bestseller products an optimal appearance! Our sales team will be happy to advise you!

Cette nouvelle présentation offre à nos produits photo best-sellers, très appréciés, une présentation optimale! Notre équipe de vente se fera un plaisir de vous conseiller!



1329 3200 ..2 / VE 3
 Fotoalbum · photo album · album photo
 Mit · with · avec Passepartout
 195 x 145 mm / 40 Seiten · pages · pages



1329 3200 9.. / VE 4
 Fotoaufsteller · photo display ·
 porte photos de bureau
 190 x 190 mm / 13 Blätter · sheets · feuilles

- 15 Denim
- 17 Stone
- 49 Taupe
- 58 Powder
- 65 Mint
- 70 Schwarz



1457 3200 ..1 / VE 3
 Fotobox · photo box · boîte photos
 Mit · with · avec Passepartout
 Magnetverschluss · magnetic closure · fermeture magnétique
 für · for · pour photos max. 130 x 180 mm



Mit Beschriftungsfeld
 With labelling field
 Avec champ d'inscription

Bitte ergänzen Sie die gewünschte Farbnummer.
 Please add colour code. · Ajoutez code couleur.



1330 3200 ..0 / VE 3
 Foto-Leporello · photo concertina ·
 album photos accordéon
 150 x 190 mm
 für · for · pour 8 photos

FOTO FOTOALBEN WIRE-O

PHOTO ALBUMS · ALBUMS PHOTOS

15	Denim
17	Stone
36	Rot
49	Taupe
58	Powder
62**	Kraft
65	Mint
70	Schwarz
90	Navy

Bezug mit Rippen-Prägung · Ribbed cover Material · Texture cannelée
 **ohne Rippen-Prägung · paper not embossed · papier non cannelé



1329 452 ..0 / VE 3 195 x 145 mm
 40 Seiten · pages · pages, schwarz



1329 452 ..1 / VE 3 195 x 145 mm
 40 Seiten · pages · pages, offwhite



1329 452 ..5 / VE 3 180 x 180 mm
 60 Seiten · pages · pages, schwarz



1329 452 ..6 / VE 3 230 x 230 mm
 60 Seiten · pages · pages, offwhite

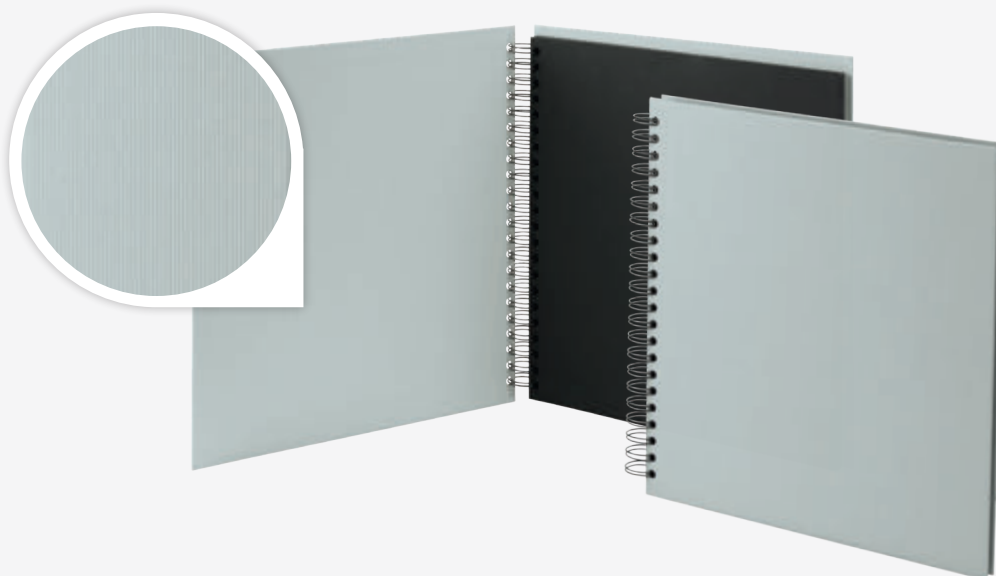

1329 452 ..7 / VE 2 290 x 290 mm, 60 Seiten · pages · pages, schwarz

FOTO-RINGBÜCHER FOTO
PHOTO RINGBINDERS · CLASSEURS POUR PHOTOS

NACHFÜLLBAR
refillable
rechargeable

230 x 210 mm
50 Seiten nachfüllbar · pages refillable ·
pages rechargeable, weiß · white · blanc



Taupe Rib
1316 1147 496 / VE 2



NEU

Schwarz Rib
1316 1147 706 / VE 2



Stone Rib
1316 1157 006 / VE 2



Mint Rib
1316 1147 656 / VE 2



Navy Rib
1316 1147 906 / VE 2



Denim Rib
1316 1174 006 / VE 2



Powder Rib
1316 1170 006 / VE 2



Rose
1316 1150 006 / VE 2



Nachfüllpack · refill pack · pack de recharge

230 x 210 mm
15 Blatt · sheets · feuilles, weiß



1316 1147 000 / VE 10



FOTO FOTO-RINGBÜCHER

PHOTO RINGBINDERS · CLASSEURS POUR PHOTOS

- 15 Denim
- 17 Stone
- 36 Rot
- 38 Opal
- 49 Taupe
- 58 Powder
- 62** Kraft
- 65 Mint
- 70 Schwarz
- 90 Navy



DIN A4 / 50 mm Füllhöhe · spine · hauteur
1316 452 ..5 / VE 3 4 Ring-Mechanik · 4 rings · 4 anneaux

Fotokarton für 4 Ring-Mechanik, 20 Blatt
photo cardboard for 4 rings, 20 sheets
carton photo 4 anneaux, 20 feuilles



1321 000 008 / VE 5



1321 000 009 / VE 5



1321 000 070 / VE 5



Spinnenpapier ·
tissue interleaf · feuilles pergamine

1321 000 900 / VE 5



Bezug mit Rippen-Prägung · Ribbed cover · Material · Texture cannelée
 **ohne Rippen-Prägung · paper not embossed · papier non cannelé

245 x 230 mm
50 Seiten · pages · pages
Mit · with · avec Passepartout



1316 1928 008 / VE 2



1316 1930 008 / VE 2



Nachfüllpack · refill pack · pack de recharge
245 x 230 mm
12 Blatt · sheets · feuilles

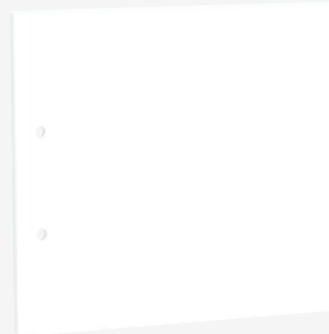

weiß
1316 1440 000 / VE 6





FOTO-NOTIZBÜCHER

Mit Passepartout zum Einstecken eines Fotos (10x15 cm)

With passepartout for inserting a photo (10x15 cm)

Avec passe-partout pour insérer une photo (10x15 cm)

192 Seiten in Offwhite, nummeriert, punktkariert

192 pages in offwhite, numbered, dotted grid

192 pages en blanc cassé, numérotées, quadrillées à points

Mit praktischer Einstecktasche

With practical insert pocket

Avec pochette pratique

1886 3200 151 / VE 3



4 014970 399817



1886 3200 171 / VE 3



4 014970 409103

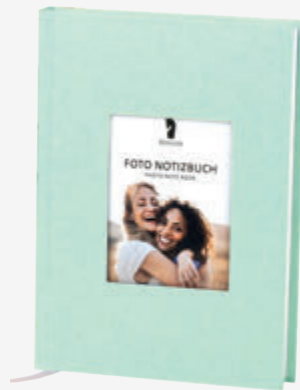

1886 3200 651 / VE 3



4 014970 399831



1886 3200 581 / VE 3



4 014970 399824



1886 3200 491 / VE 3



4 014970 409110



1886 3200 701 / VE 3



4 014970 399848

FOTO FOTOALBEN WIRE-O – MIT MOTIV
 PHOTO ALBUMS · ALBUMS PHOTOS



HEISSFOLIE
WEISS
Hot foil
Impression

1329 3301 000 / VE 3

195 x 145 mm
40 Seiten · pages ·
pages / schwarz

4 014970 399336



1329 1955 000 / VE 3

195 x 145 mm
40 Seiten · pages ·
pages / weiß

4 014970 429224



1329 1977 000 / VE 3

195 x 145 mm
40 Seiten · pages ·
pages / weiß

4 014970 438035



HEISSFOLIE
SCHWARZ
Hot foil
Impression

1329 1958 000 / VE 3

195 x 145 mm
40 Seiten · pages ·
pages / offwhite

4 014970 429910



HEISSFOLIE
GOLD
Hot foil
Impression

1329 1956 000 / VE 3

195 x 145 mm
40 Seiten · pages ·
pages / offwhite

4 014970 429064



Mit · with ·
avec
Passepartout

1329 6180 002 / VE 3

195 x 145 mm
40 Seiten · pages ·
pages / weiß

4 014970 405037



Mit · with ·
avec
Passepartout

1329 1928 002 / VE 3

4 014970 408809



Mit · with ·
avec
Passepartout

1329 1930 002 / VE 3

4 014970 408816



Mit · with ·
avec
Passepartout

1329 6181 002 / VE 3

195 x 145 mm
40 Seiten · pages ·
pages / weiß

4 014970 405105

FOTOALBEN MIT VERDECKTER WIRE-O-BINDUNG FOTO
 PHOTO & GUEST BOOKS · ALBUMS PHOTOS & LIVRES D'OR



HEISSFOLIE
 SCHWARZ
 Hot foil
 Impression

1329 1958 006 / VE 2
 „Every Photo tells a Story“
 230 x 230 mm
 60 Seiten · pages · pages / offwhite

4 014970 430503



1329 1960 006 / VE 2
 230 x 230 mm
 60 Seiten · pages · pages / offwhite

4 014970 429477



1329 1955 006 / VE 2
 230 x 230 mm
 60 Seiten · pages · pages / weiß

4 014970 429231



HEISSFOLIE
 GOLD
 Hot foil
 Impression

1329 1956 006 / VE 2
 230 x 230 mm
 60 Seiten · pages · pages / offwhite

4 014970 429071



HEISSFOLIE
 SCHWARZ
 Hot foil
 Impression

1877 1958 006 / VE 2
 „Wunderbare Momente“
 220 x 230 mm
 60 Seiten · pages · pages / offwhite

4 014970 429903



1877 1960 006 / VE 2
 230 x 220 mm
 60 Seiten · pages · pages / offwhite

4 014970 429583



1877 1964 006 / VE 2
 230 x 220 mm
 60 Seiten · pages · pages / offwhite

4 014970 429866

FOTO FOTOALBEN MIT VERDECKTER WIRE-O-BINDUNG
 PHOTO & GUEST BOOKS · ALBUMS PHOTOS & LIVRES D'OR



1877 1928 006 / VE 2

230 x 220 mm
 60 Seiten · pages · pages
 Mit · with · avec Passepartout

4 014970 408960



1877 1930 006 / VE 2

230 x 220 mm
 60 Seiten · pages · pages
 Mit · with · avec Passepartout

4 014970 408977



1877 6180 006 / VE 2

230 x 220 mm
 60 Seiten · pages · pages / weiß
 Mit · with · avec Passepartout

4 014970 405068



1877 6181 006 / VE 2

230 x 220 mm
 60 Seiten · pages · pages / weiß
 Mit · with · avec Passepartout

4 014970 405136

230 x 220 mm
 60 Seiten · pages · pages, offwhite
 Heißfolie Gold · hot foil · avec impression



1877 7157 006 / VE 2

4 014970 171109

230 x 220 mm
 60 Seiten · pages · pages, offwhite
 Heißfolie Gold · hot foil · avec impression



1877 7150 006 / VE 2

4 014970 170034

230 x 220 mm
 60 Seiten · pages · pages, weiß



1877 7170 7176 / VE 2

4 014970 216107

FOTOALBEN MIT VERDECKTER WIRE-O-BINDUNG FOTO
 PHOTO & GUEST BOOKS · ALBUMS PHOTOS & LIVRES D'OR



1877 7191 206 / VE 2



230 x 220 mm, offwhite
 60 Seiten · pages · pages
 Heißfolie Gold · hot foil · avec impression



1877 7191 306 / VE 2



230 x 220 mm, offwhite
 60 Seiten · pages · pages
 Heißfolie Gold · hot foil · avec impression



1877 7191 106 / VE 2



230 x 220 mm, offwhite
 60 Seiten · pages · pages
 Heißfolie Gold · hot foil · avec impression



1877 7190 106 / VE 2



230 x 220 mm, offwhite
 60 Seiten · pages · pages
 Heißfolie Gold · hot foil · avec impression



1877 822 005 / VE 2



220 x 180 mm
 60 Seiten · pages · pages

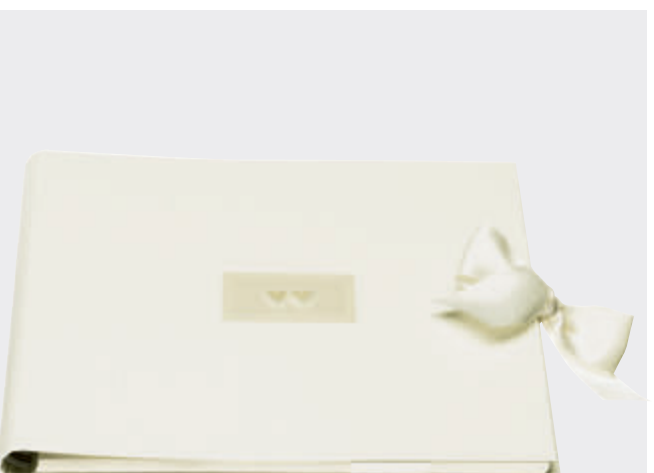

1877 822 007 / VE 2



290 x 240 mm
 60 Seiten · pages · pages



IDEAL ZU KOMBINIEREN MIT S.O.H.O.

IDEAL TO COMBINE WITH S.O.H.O.

IDÉAL POUR COMBINER AVEC S.O.H.O.

COLOUR FRAMES BILDERRAHMEN AUS PAPIER

Nachhaltig, hochwertig, vielseitig: Die Bilderrahmen „Colour Frames“ von Rössler bringen Farbe und stilvolles Ambiente in jedes Zuhause, Home Office und Büro. Erhältlich in sechs attraktiven Farben, besonders leicht zu montieren und sehr stabil.

Picture frames made of paper:
Sustainable, high-quality, versatile: “Colour Frames” from Rössler bring colour and a stylish ambience to every home, home office and office. Particularly easy to assemble and very solid.

Cadres photos en papier:
Durables, de haute qualité, polyvalents: “Colour Frames” de Rössler apportent de la couleur et une ambiance élégante à chaque maison, bureau à domicile et bureau. Particulièrement faciles à assembler et très solides.

09	White
15	Denim
49	Taupe
58	Powder
65	Mint
70	Schwarz



EINZIGARTIGER EFFEKT DURCH ZUSÄTZLICHE PASSEPARTOUTS

Unique effect through additional passepartouts · Effet unique grâce à des passe-partout supplémentaires

Für Fotos · for photos · pour photos
10 x 15 cm | **1300 452 ..0** | VE 4
Sortierung 6 x 2 | **1300 452 990** | VE 12
Außenmaße · dimensions (220 x 170 x 31 mm)

Für Fotos · for photos · pour photos
13 x 18 cm | **1300 452 ..1** / VE 4
Sortierung 6 x 2 | **1300 452 991** | VE 12
Außenmaße · dimensions (252 x 202 x 31 mm)

Für Fotos · for photos · pour photos
13 x 13 cm | **1300 452 ..5** | VE 4
Sortierung 6 x 2 | **1300 452 995** | VE 12
Außenmaße · dimensions (201 x 201 x 31 mm)

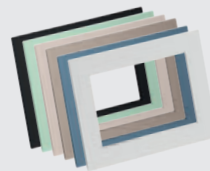

Passepartouts | **1301 452 990** | VE 12
Sortierung · assorted · assortis 6 x 2

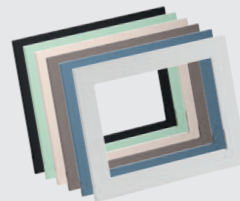

Passepartouts | **1301 452 991** | VE 12
Sortierung · assorted · assortis 6 x 2

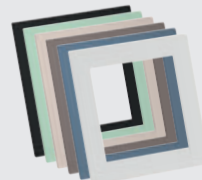

Passepartouts | **1301 452 995** | VE 12
Sortierung · assorted · assortis 6 x 2

DAS PRODUKT

- Hergestellt in der EU
- Nachhaltige Materialien
- Hohe Stabilität
- Einzigartige Haptik
- Farbiger Standfuß
- Praktische Wandaufhängevorrichtung

THE PRODUCT

- Made in the EU
- Sustainable materials
- High stability
- Unique feel
- Coloured stand
- Practical wall hanging device

LE PRODUIT

- Fabriqué dans l'UE
- Matériaux durables
- Haute stabilité
- Sensation unique
- Support coloré
- Dispositif de suspension mural pratique

FOTO GÄSTEBÜCHER
GUEST BOOKS · LIVRES D'OR



1878 1002 004 / VE 2

210 x 210 mm
96 Blatt · sheets · feuilles
Heißfolie Silber · hot foil · avec impression

4 014970 084447



1878 1002 104 / VE 2

210 x 210 mm
96 Blatt · sheets · feuilles
Heißfolie Gold · hot foil · avec impression

4 014969 573969

MIT FEINEM STOFF BEZOGEN UND MIT HEISSFOLIE VEREDELT.

Books are covered in fine fabric.
Les albums reliés sont recouverts d'un tissu raffiné.



1878 1002 124 / VE 2

210 x 210 mm
96 Blatt · sheets · feuilles
Heißfolie Gold · hot foil · avec impression

4 014969 574249



1878 1002 204 / VE 2

210 x 210 mm
96 Blatt · sheets · feuilles
Heißfolie Silber · hot foil · avec impression

4 014970 084560



1878 1002 494 / VE 2

210 x 210 mm
96 Blatt · sheets · feuilles
Heißfolie Silber · hot foil · avec impression

4 014970 215773



1878 1002 724 / VE 2

210 x 210 mm
96 Blatt · sheets · feuilles
Heißfolie Gold · hot foil · avec impression

4 014969 573990





SCHREIBEN FÜR DIE EDLE KORRESPONDENZ

Schreibkultur in Perfektion für alle Liebhaber stilvoller Korrespondenz.
Klassische Briefpapiere, die den Füller sanft über das Papier gleiten lassen.
Feine Schreibpapiere präsentiert in handgefertigten Mappen und Kassetten.

Writing culture in perfection. Classic stationery that lets the fountain pen glide smoothly over the paper. Fine writing papers presented in hand-made folders and cassettes.







La culture de l'écriture à la perfection. Des articles de papeterie classiques qui permettent au stylo-plume de glisser en douceur sur le papier, présentés dans des compendiums et des boîtes fabriquées à la main.



PAPER ROYAL EDLES SCHREIBEN

Elegantes, geripptes Schreibpapier und passende Briefumschläge mit farblich abgestimmtem Seidenfutter.
Elegantly laid writing paper and envelopes with colour coordinated lining · Un élégant papier vergé.

Erhältlich in 3 verschiedenen Farbvarianten:
available in 3 different colour options · disponible en 3 options de couleurs différentes:

MAPPE/KASSETTE COMPENDIUM/BOX COMPENDIUM/BOÎTE	PAPIER PAPER PAPIER	INNENFUTTER BRIEFUMSCHLAG ENVELOPE LINING · DOUBLURE ENVELOPPE
	CHAMOIS 08	
	WEISS · WHITE · BLANC 09	
	EISGRAU · ICE GRAY · GLAS GRIS 170	

25/25, DIN A4/DL, 100 g/m²



Marine 1024 831 009 / VE 2 Grün 1024 831 008 / VE 2 Bordeaux 1024 831 170 / VE 2



15/15, DIN A5/C6, 100 g/m²



Marine 1026 831 009 / VE 3 Grün 1026 831 008 / VE 3 Bordeaux 1026 831 170 / VE 3



40/10/50,
DIN A4/
DL/DL



Marine 1051 831 009 / VE 1 Grün 1051 831 008 / VE 1 Bordeaux 1051 831 170 / VE 1



15/15, DL/DL



Marine 1056 831 009 / VE 3 Grün 1056 831 008 / VE 3 Bordeaux 1056 831 170 / VE 3





RÖSSLER BÜTTEN SCHREIBKULTUR IN PERFEKTION

Rössler Bütten – ein einzigartiges Papier, das Schreibkultur in Perfektion bietet. Sein hoher Baumwollanteil macht es besonders weich und geschmeidig und lässt den Füller nur so dahingleiten. Der traditionelle von Hand gerissene Rand unterstreicht die herausragende Qualität dieses Premium-Papieres aus deutscher Herstellung. Einen Brief zu schreiben auf Büttenpapier, das ist ein Erlebnis für alle Liebhaber edler Schreibkultur.

Deckle-edged paper is a unique paper that offers writing culture in perfection. Its high cotton content makes it particularly soft and supple and lets the fountain pen just glide along. The traditional hand-torn edge underlines the outstanding quality of this premium paper from German production. Writing a letter on deckle-edged paper is an experience for all lovers of fine writing culture.

Bütten – un papier unique qui offre une culture de l'écriture à la perfection. Sa teneur élevée en coton le rend particulièrement doux et souple et permet au stylo de glisser sans effort. Le bord traditionnel déchiré à la main souligne la qualité exceptionnelle de ce papier premium de fabrication allemande. Écrire une lettre sur du papier à la cuve est une expérience pour tous les amateurs d'écriture raffinée.



1051 1900 201 / VE 1

40 / DIN A4 Blätter · sheets · feuilles
 10 / DL Einzelkarten · flat cards · cartes simples
 50 / DL Briefumschläge · envelopes · enveloppes

4 014970 381508

1026 1900 201 / VE 3

15 / DIN A5 Blätter · sheets · feuilles
 15 / C6 Briefumschläge · envelopes · enveloppes

4 014970 381485

1024 1900 201 / VE 3

20 / DIN A4 Blätter · sheets · feuilles
 5 / DL Einzelkarten · flat cards · cartes simples
 25 / DL Briefumschläge · envelopes · enveloppes

4 014970 381478

1056 1900 201 / VE 3

15 / DL Einzelkarten · flat cards · cartes simples
 15 / DL Briefumschläge · envelopes · enveloppes

4 014970 381515

1049 1900 201 / VE 2

10 / DIN A4 Blätter · sheets · feuilles
 5 / DL Einzelkarten · flat cards · cartes simples
 15 / DL Briefumschläge · envelopes · enveloppes

4 014970 381492

EDLES SCHREIBEN SIGNATURE



HEISSFOLIE
GOLD & SCHWARZ
Hot foil
Impression

1874 1968 001 / VE 3
DIN A5/ 160 Seiten · pages · pages
mit Heißfolie · hot foil · avec impression
Papier · paper · papier: Weiß · white · blanc (09)

2032 1968 000 / VE 5
20 / DL Briefumschläge · envelopes · enveloppes
mit Seidenfutter · tissue lining · doubles en
papier de soie
Papier · paper · papier: Weiß · white · blanc (09)



HEISSFOLIE
GOLD & SCHWARZ
Hot foil
Impression

1210 1968 000 / VE 5
DIN A4, 40 Blätter · sheets · feuilles
Heißfolie · hot foil · avec impression
Papier · paper · papier: Weiß · white · blanc (09)

1211 1968 001 / VE 5
DIN A5, 40 Blätter · sheets · feuilles
Heißfolie · hot foil · avec impression
Papier · paper · papier: Weiß · white · blanc (09)



HEISSFOLIE
GOLD & SCHWARZ
Hot foil
Impression

1078 1968 009 / VE 2
25 / DIN A4 Blätter · sheets · feuilles
5 / DL Einzelkarten · flat cards · cartes simples
25 / DL Briefumschläge · envelopes · enveloppes
Papier · paper · papier: Weiß · white · blanc (09)

1079 1968 009 / VE 2
25 / DIN A5 Blätter · sheets · feuilles
5 / DIN A6 Einzelkarten · flat cards · cartes simples
25 / C6 Briefumschläge · envelopes · enveloppes
Papier · paper · papier: Weiß · white · blanc (09)

Produktionsbedingte Änderungen vorbehalten.
May be subject to modification for production reasons.
La production sujette à des modifications.



EDLES SCHREIBEN RÜCKWAND-PRÄSENTATION

IDEAL ZU INTEGRIEREN IN DEN RÖSSLER-MARKENAUFTRITT

IDEAL FOR INTEGRATION INTO THE RÖSSLER BRAND PRESENCE

IDÉAL À INTÉGRER DANS L'IMAGE DE MARQUE DE RÖSSLER

OPTIMALE PRÄSENTATION MIT LICHT

OPTIMAL PRESENTATION WITH LIGHT

PRÉSENTATION OPTIMALE AVEC LA LUMIÈRE

INTERAKTION & INFORMATION

INTERACTION & INFORMATION

BESTSELLER PRODUKTE

BESTSELLING PRODUCTS

PRODUITS BEST-SELLERS

GROßE PRODUKTVIELFALT

GREAT PRODUCT DIVERSITY

GRANDE VARIÉTÉ DE PRODUITS



SCHREIBKULTUR IN PERFEKTION NEUE RÜCKWAND- PRÄSENTATION ELEGANT. INTERAKTIV. INFORMATIV.

Ein neuer Auftritt für unsere erfolgreichen und zeitlosen Produkte rund um das Thema Schreibkultur. Entstanden ist eine Präsentation, die den Kunden zum Ausprobieren vor Ort ermuntert und gleichzeitig viele nützliche Informationen zu den jeweiligen Produkten liefert – von der Bedruckbarkeit über die Beschaffenheit der Papiere bis hin zu Nachhaltigkeitszertifizierungen. Ein neues Rückwandmöbel, das präsentiert, animiert und informiert. Unser Vertriebsteam berät Sie gerne!

A new appearance for our successful and timeless products around the topic of writing culture. The result is a presentation that encourages customers to try out the products on site and at the same time provides a lot of useful information about the respective products. Our sales team will be happy to advise you!



Une nouvelle présentation pour nos produits intemporels et à succès sur le thème de l'écriture. Il en résulte une présentation qui encourage les clients à essayer les produits sur place et qui fournit en même temps de nombreuses informations utiles sur les différents produits. Notre équipe de vente se fera un plaisir de vous conseiller!



EDLES SCHREIBEN KORRESPONDENZPAPIERE – PAPER ROYAL

Elegantes, geripptes Schreibpapier und passende Briefumschläge mit farblich abgestimmtem Seidenfutter.
 Elegantly laid writing paper and envelopes with colour coordinated lining · Un élégant papier vergé.

Erhältlich in 3 verschiedenen Farbvarianten:
 Available in 3 different colour options · Disponible en 3 options de couleurs différentes:

PAPIER PAPER PAPIER		INNENFUTTER BRIEFUMSCHLAG ENVELOPE LINING DOUBLURE ENVELOPPE
CHAMOIS	08	
WEISS · WHITE · BLANC	09	
EISGRAU · ICE GRAY · GLAS GRIS	170	



40 / DIN A4 Blätter · sheets · feuilles



2002 831 008 / VE 10 2002 831 009 / VE 10 2002 831 170 / VE 10



20 / DL Briefumschläge · envelopes · enveloppes
 mit farbigem Seidenfutter
 coloured tissue lining
 doublées en papier de soie coloré



2033 831 008 / VE 5 2033 831 009 / VE 5 2033 831 170 / VE 5



PAPER ROYAL – KORRESPONDENZPAPIERE EDLES SCHREIBEN

20 / DL
Einzelkarten · flat cards · cartes simples

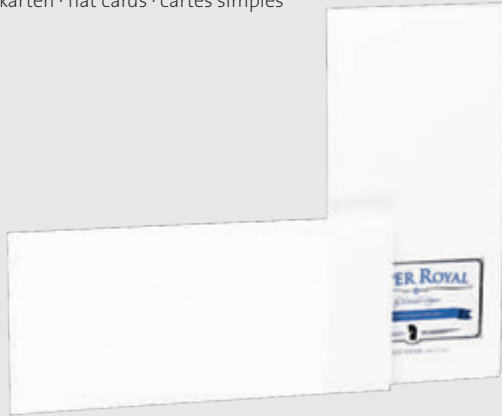

2051 831 008 / VE 5 2051 831 009 / VE 5 2051 831 170 / VE 5



20 / DIN A6
Einzelkarten · flat cards · cartes simples



2052 831 008 / VE 5 2052 831 009 / VE 5 2052 831 170 / VE 5



20 / DIN A6 HD
Doppelkarten · folded cards · cartes doubles



2160 831 008 / VE 5 2160 831 009 / VE 5 2160 831 170 / VE 5



20 / C6 Briefumschläge · envelopes · enveloppes
mit farbigem Seidenfutter · coloured tissue lining · doubles en
papier de soie coloré



2031 831 008 / VE 5 2031 831 009 / VE 5 2031 831 170 / VE 5



8 / DIN A6 Doppelkarten · folded cards · cartes doubles
8 / C6 Briefumschläge · envelopes · enveloppes



2234 831 008 / VE 5 2234 831 009 / VE 5 2234 831 170 / VE 5

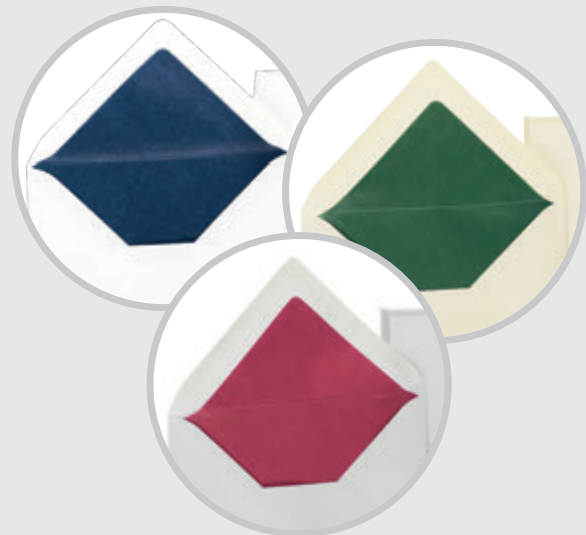

EDLES SCHREIBEN KORRESPONDENZPAPIERE – EDEL SATIN

Klassisches 100 g/m² Papier mit satiniertes Oberfläche.

Classic 100 g/m² satin paper.

Un papier classique au toucher satiné, grammage 100 g/m².

Erhältlich in 2 Farben:

Available in 2 colours · Disponible en 2 couleurs:

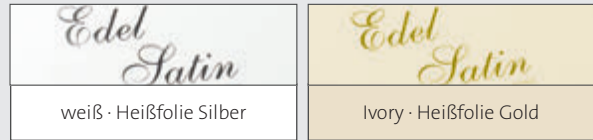

40 / DIN A4 Blätter · sheets · feuilles



2003 838 001 / VE 10

2003 838 004 / VE 10



20 / DL Briefumschläge · envelopes · enveloppes
mit Seidenfutter · tissue lining
doublees en papier de soie

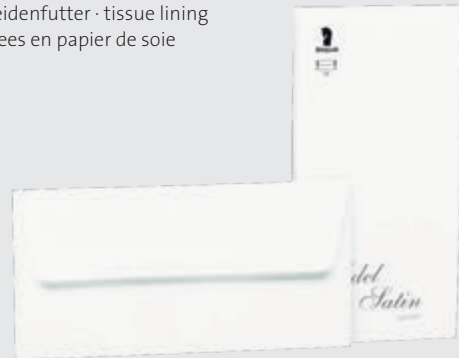

2032 838 001 / VE 5

2032 838 004 / VE 5



20 / DL
Einzelkarten · flat cards · cartes simples



2051 838 001 / VE 5

2051 838 004 / VE 5



8 / DIN A6 Doppelkarten · folded cards · cartes doubles
8 / C6 Briefumschläge · envelopes · enveloppes



2234 838 001 / VE 5

2234 838 004 / VE 5



20 / C6 Briefumschläge · envelopes · enveloppes
mit Seidenfutter · tissue lining
doublees en papier de soie



2031 838 001 / VE 5

2031 838 004 / VE 5



20 / DIN A6 Doppelkarten · folded cards · cartes doubles



2160 838 001 / VE 5



2160 838 004 / VE 5



20 / DIN A6 Einzelkarten · flat cards · cartes simples



2052 838 001 / VE 5



2052 838 004 / VE 5



EDEL LEINEN – KORRESPONDENZPAPIERE EDLES SCHREIBEN



Edles 100 g/m² Papier mit zeitloser Leinenprägung.

100 g/m² paper with classic linen embossing.

Un papier classique ayant l'aspect du lin, grammage 100 g/m².

Erhältlich in 2 Farben:

Available in 2 colours · Disponible en 2 couleurs:

	
weiß · Heißfolie Silber	Ivory · Heißfolie Gold

40 / DIN A4 Blätter · sheets · feuilles
Heißfolie · hot foil · impression



2003 705 002 / VE 10

2003 705 802 / VE 10



20 / DL Briefumschläge · envelopes · enveloppes
mit Seidenfutter · tissue lining ·
doublees en papier de soie



2032 705 002 / VE 5

2032 705 802 / VE 5



20 / DL
Einzelkarten · flat cards · cartes simples



2051 705 002 / VE 5

2051 705 802 / VE 5



8 / DIN A6 Doppelkarten · folded cards · cartes doubles
8 / C6 Briefumschläge · envelopes · enveloppes



2234 705 002 / VE 10

2234 705 802 / VE 10



20 / C6 Briefumschläge · envelopes · enveloppes
mit Seidenfutter · tissue lining
doublees en papier de soie



2031 705 002 / VE 5

2031 705 802 / VE 5



20 / DIN A6 Doppelkarten ·
folded cards · cartes doubles



2160 705 002 / VE 5



2160 705 802 / VE 5



20 / DIN A6 Einzelkarten ·
flat cards · cartes simples



2052 705 002 / VE 5



2052 705 802 / VE 5



EDLES SCHREIBEN KORRESPONDENZPAPIERE – EDELBÜTTEN

100 g/m² Papier mit Hammerschlagprägung und imitiertem Büttenrand.

Hammer embossed 100 g/m² paper.

Un papier embossé au marteau, grammage 100 g/m².

Erhältlich in 2 Farben:

Available in 2 colours · Disponible en 2 couleurs:

<i>Edelbüttlen</i>	<i>Edelbüttlen</i>
weiß · Heißfolie Silber	Ivory · Heißfolie Gold

40 / DIN A4 Blätter · sheets · feuilles
Heißfolie · hot foil · impression



2003 388 003 / VE 10

2003 388 803 / VE 10



20 / DL Briefumschläge · envelopes · enveloppes
mit Seidenfutter · tissue lining
doublees en papier de soie



2032 388 003 / VE 5

2032 388 803 / VE 5



20 / DL Einzelkarten · flat cards · cartes simples



2051 388 003 / VE 5

2051 388 803 / VE 5



8 / DIN A6 Doppelkarten · folded cards · cartes doubles
8 / C6 Briefumschläge · envelopes · enveloppes



2234 388 003 / VE 10

2234 388 803 / VE 10



20 / C6 Briefumschläge · envelopes · enveloppes
mit Seidenfutter · tissue lining
doublees en papier de soie



2031 388 003 / VE 5

2031 388 803 / VE 5



20 / DIN A6 Doppelkarten · folded cards · cartes double



2160 388 003 / VE 5



2160 388 803 / VE 5



20 / DIN A6 Einzelkarten · flat cards · cartes simples



2052 388 003 / VE 5



2052 388 803 / VE 5



DÜRENER TRADITION – KORRESPONDENZPAPIERE EDLES SCHREIBEN

Ein Stück Tradition aus der Papierstadt Düren.

A piece of tradition from the town of Düren famous for its paper tradition.

Un peu de tradition de Düren, la ville du papier.

Erhältlich in 2 Papiervarianten:

Available in 2 types of paper · Disponible en 2 types de papier:

WEISS SATINIERT

WEISS LEINEN

50 / DIN A4 Blätter · sheets · feuilles, 90 g/m²



Weiß Satiniert
2002 04 01 / VE 10

Weiß Leinen
2002 04 02 / VE 10



50 / DIN A5 Blätter · sheets · feuilles



Weiß Satiniert
2000 04 01 / VE 10



25 / DIN A6
Einzelkarten · flat cards · cartes simples



Satiniert
2010 04 01 / VE 10

Leinen
2010 04 02 / VE 10



25 / C6 Briefumschläge · envelopes · enveloppes
mit Seidenfutter · tissue lining ·
doublees en papier de soie



Satiniert
2031 04 01 / VE 20

Leinen
2031 04 02 / VE 20



25 / DL Briefumschläge · envelopes · enveloppes
mit Seidenfutter · tissue lining ·
doublees en papier de soie



Satiniert
2033 04 01 / VE 10

Leinen
2033 04 02 / VE 10



25/25 / DIN A6/C6
Einzelkarten · flat cards · cartes simples



Satiniert
2230 04 01 / VE 20



EDLES SCHREIBEN KORRESPONDENZPAPIERE – RÖSSLER BÜTTEN



EIN PAPIER MIT TRADITION

Rössler Büttlen mit von Hand gerissenem Rand.

Traditional deckle-edged paper.

Le papier dans la tradition. Un papier élégant avec bord déchiré à la main.

40 / DIN A4 Blätter · sheets · feuilles



2003 38 01 / VE 5



4 014969 007495

20 / DL Briefumschläge · envelopes · enveloppes
mit Seidenfutter · tissue lining ·
doublees en papier de soie



2032 38 01 / VE 5



4 014969 007501

10 / DIN A6 HD Doppelkarten · folded cards · cartes doubles
10 / C6 Briefumschläge · envelopes · enveloppes



2234 38 01 / VE 10



4 014969 007488

20 / DL Einzelkarten · flat cards · cartes simples
20 / DL Briefumschläge · envelopes · enveloppes



2241 38 01 / VE 5



4 014969 007396

RÖSSLER BÜTTEN PACKWARE – KORRESPONDENZPAPIERE EDLES SCHREIBEN

BÜTTENPAPIER
VON HAND GERISSEN
hand-torn
déchiré à la main



1104 001 201 / VE 10



4 014970 189821

5 DIN A4 Blätter · sheets · feuilles

5 DL Briefumschläge · envelopes · enveloppes
mit Seidenfutter · tissue lining · doublées en papier de soie



1104 002 201 / VE 5



4 014970 189838

5 / DL Einzelkarten · flat cards · cartes simples



1104 127 201 / VE 5



4 014970 368400

5 / DIN A6 Doppelkarten · folded cards ·
cartes doubles



1104 006 201 / VE 5



4 014970 368387

5 / C6 Briefumschläge · envelopes · enveloppes
mit Seidenfutter · tissue lining · doublées en
papier de soie



1104 005 201 / VE 5



4 014970 189845

5 / B6 Doppelkarten · folded cards · cartes doubles



1104 019 201 / VE 5



4 014970 368394

5 / B6 Briefumschläge · envelopes · enveloppes
mit Seidenfutter · tissue lining · doublées en papier de soie



1104 020 201 / VE 5



4 014970 189869

5 / DIN A5 hd plano Doppelkarten · folded cards · cartes doubles



1104 071 201 / VE 5



4 014970 189890

5 / C5 Briefumschläge · envelopes · enveloppes
mit Seidenfutter · tissue lining · doublées en papier de soie



1104 011 201 / VE 5



4 014970 189852

EDLES SCHREIBEN KORRESPONDENZPAPIERE

Erhältlich in 2 Farben:
Available in 2 colours:
Disponible en 2 couleurs:



40 / DIN A4 Blätter · sheets · feuilles
Heißfolie · hot foil · impression



2003 08 06 / VE 10

2003 08 14 / VE 10



4 014969 002186



4 014969 002193

20 / DL Briefumschläge · envelopes · enveloppes



2032 08 06 / VE 5

2032 08 14 / VE 5



4 014969 002209



4 014969 002216

10 / FT. 18 Doppelkarten · folded cards · cartes doubles
10 / FT. 18 Briefumschläge · envelopes · enveloppes



2120 10 04 / VE 10

2120 10 01 / VE 10



4 014969 002728



4 014969 002711

10 / DIN A6 Doppelkarten · folded cards · cartes doubles
10 / C6 Briefumschläge · envelopes · enveloppes



2100 10 04 / VE 10

2100 10 01 / VE 10



4 014969 002568



4 014969 002544

35 / DIN A4 Blätter · Sheets · Feuilles
Hochwertiges Papier mit Wasserzeichen, lose verpackt
premium quality watermarked paper, packed lose
papier de qualité supérieure, idéal pour des certaines applications



2300 32 01 / VE 10



4 014969 368046

20 / DIN A4 Blätter, beidseitig bedruckt
sheets printed on both sides
feuilles imprimées sur les deux côtés



2002 390 000 / VE 10



4 014969 545812

BÜTTEN – KORRESPONDENZPAPIERE EDLES SCHREIBEN

Erhältlich in 2 Farben:
Available in 2 colours:
Disponible en 2 couleurs:

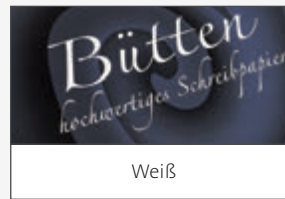

Weiß

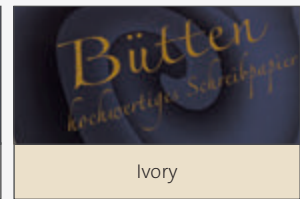

Ivory

50 / DIN A4 Blätter · sheets · feuilles, 80 g/m²
gewellter Rand · wavy edge · bord ondulé



2020 19 30 / VE 10

2020 19 40 / VE 10



4 014969 515426



4 014969 515471

25 / DL Briefumschläge · envelopes · enveloppes
mit Seidenfutter · tissue lining · doubles en papier de soie



2026 19 30 / VE 10

2026 19 40 / VE 10



4 014969 596036



4 014969 596067

10 / DIN A6 Doppelkarten · folded cards · cartes doubles
10 / C6 Briefumschläge · envelopes · enveloppes
mit Seidenfutter · tissue lining · doubles en papier de soie
gewellter Rand · wavy edge · bord ondulé



2024 19 30 / VE 10

2024 19 40 / VE 10



4 014969 534786



4 014969 534809

25 / DIN A6 Einzelkarten · flat cards · cartes simples
25 / C6 Briefumschläge · envelopes · enveloppes
mit Seidenfutter · tissue lining · doubles en papier de soie
gewellter Rand · wavy edge · bord ondulé



2027 19 40 / VE 10



4 014969 596104

25 / DIN A6
Doppelkarten · folded cards · cartes doubles
gewellter Rand · wavy edge · bord ondulé



2022 19 30 / VE 10

2022 19 40 / VE 10



4 014969 515433



4 014969 535134

25 / C6 Briefumschläge · envelopes · enveloppes
mit Seidenfutter · tissue lining · doubles en papier de soie



2021 17 11 / VE 10

2021 19 40 / VE 10



4 014969 515457



4 014969 515488

50 / DIN A6
Einzelkarten · flat cards · cartes simples
gewellter Rand · wavy edge · bord ondulé



2025 19 30 / VE 10



4 014969 596197

EDLES SCHREIBEN KORRESPONDENZPAPIERE – EXCELLENT

Erhältlich in 1 Farbe:
Available in 1 colour:
Disponible en 1 couleur:



50 / DIN A4 Blätter · sheets · feuilles, 80 g/m²



2020 17 11 / VE 10



25 / DL Briefumschläge · envelopes · enveloppes
mit Seidenfutter · tissue lining ·
doublees en papier de soie



2026 17 11 / VE 10



10 / DIN A6 Doppelkarten · folded cards · cartes doubles
10 / DIN A6 Briefumschläge · envelopes · enveloppes
mit Seidenfutter · tissue lining · doublees en papier de soie



2024 19 11 / VE 10



10 / DL Doppelkarten · folded cards · cartes doubles
10 / DL Briefumschläge · envelopes · enveloppes
mit Seidenfutter · tissue lining · doublees en papier de soie



2023 17 11 / VE 10



25 / DIN A6
Doppelkarten · folded cards · cartes doubles



2022 17 11 / VE 10



25 / C6 Briefumschläge · envelopes · enveloppes
mit Seidenfutter · tissue lining ·
doublees en papier de soie



2021 19 30 / VE 10



50 / DIN A6
Einzelkarten · flat cards ·
cartes simples



2025 17 11 / VE 10



BRILLANTLEINEN – KORRESPONDENZPAPIERE EDLES SCHREIBEN

Erhältlich in 2 Farben:
Available in 2 colours:
Disponible en 2 couleurs:

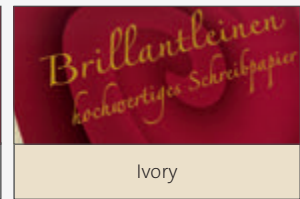
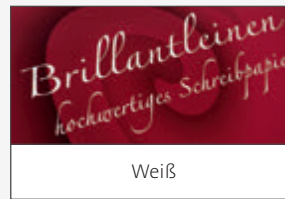

50 / DIN A4 Blätter · sheets · feuilles, 80 g/m²



2020 18 33 / VE 10

2020 18 34 / VE 10



25 / DL Briefumschläge · envelopes · enveloppes
mit Seidenfutter · tissue lining ·
doublées en papier de soie



2026 18 33 / VE 10

2026 18 34 / VE 10



10 / DIN A6 Doppelkarten · folded cards · cartes doubles
10 / DIN A6 Briefumschläge · envelopes · enveloppes
mit Seidenfutter · tissue lining · doublées en papier de soie



2024 19 33 / VE 10



10 / DL Doppelkarten · folded cards · cartes doubles
10 / DL Briefumschläge · envelopes · enveloppes
mit Seidenfutter · tissue lining · doublées en papier de soie



2023 18 34 / VE 10



25 / DIN A6
Doppelkarten · folded cards · cartes doubles



2022 18 33 / VE 10

2022 18 34 / VE 10



25 / C6 Briefumschläge · envelopes · enveloppes
mit Seidenfutter · tissue lining ·
doublées en papier de soie



2021 18 33 / VE 10

2021 18 34 / VE 10



50 / DIN A6
Einzelkarten · flat cards ·
cartes simples



2025 18 33 / VE 10



EDLES SCHREIBEN TRAUERPOST

TRAUERPOST

Hochwertige Karten und Briefumschläge für die klassische Trauerpost. Veredelt mit dem traditionellen schwarzen Trauerrand, der nach alter Handwerkskunst millimetergenau und von Hand in unserer Manufaktur aufgetragen wird.

Funeral mail: hand-bordered cards and envelopes for classic funeral mail.

Faire-part: cartes et enveloppes bordées à la main pour le courrier funéraire classique.

5 / DIN A5 hd Bogen · folded sheets · feuilles doubles
5 / C6 Briefumschläge · envelopes · enveloppes
mit Seidenfutter · tissue lining · doublées en papier de soie

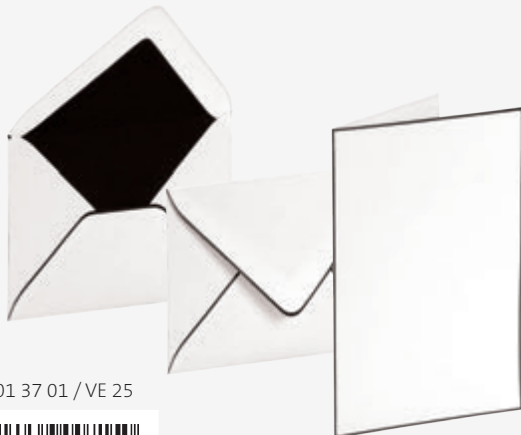

2201 37 01 / VE 25



4 014969 007150

5 / 178 x 215 mm (Ft. 18 hd) Bogen · folded sheets · feuilles doubles
5 / 189 x 120 mm (Ft. 18) Briefumschläge · envelopes · enveloppes
mit Seidenfutter · tissue lining · doublées en papier de soie

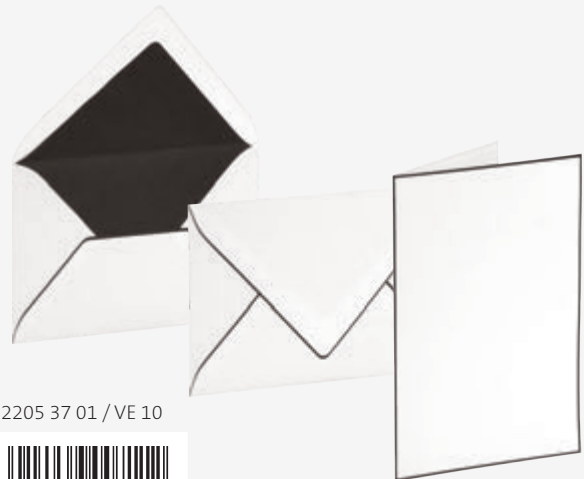

2205 37 01 / VE 10



4 014969 007112

5 / DIN A6 Einzelkarten · flat cards · cartes simples
5 / C6 Briefumschläge · envelopes · enveloppes
mit Seidenfutter · tissue lining · doublées en papier de soie



2231 37 01 / VE 25



4 014969 007136

5 / 117 x 183 mm (Ft. 18) Einzelkarten · flat cards · cartes simples
5 / 189 x 120 mm (Ft. 18) Briefumschläge · envelopes · enveloppes
mit Seidenfutter · tissue lining · doublées en papier de soie

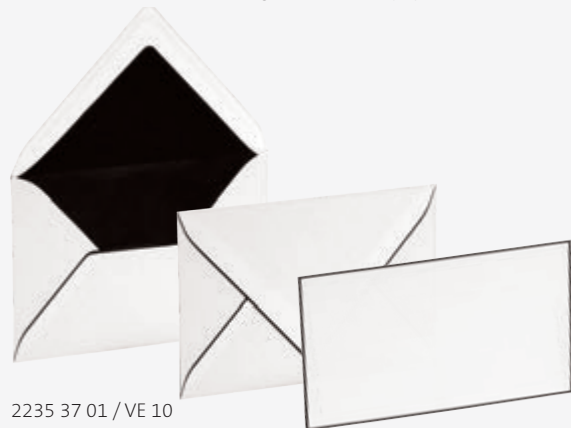

2235 37 01 / VE 10



4 014969 007099

5 / DIN A6 ld Doppelkarten · folded cards · cartes doubles
5 / C6 Briefumschläge · envelopes · enveloppes
mit Seidenfutter · tissue lining · doublées en papier de soie



2237 37 01 / VE 10



4 014969 007181



EDLES SCHREIBEN TERRA NATURPAPIERE

3x B6 hd Karten · cards · cartes
3x B6 Briefumschläge · envelopes · enveloppes
Denim



1193 1675 629/VE 6



3x B6 hd Karten · cards · cartes
3x B6 Briefumschläge · envelopes · enveloppes
Kiwi



1193 1675 637/VE 6



3x B6 hd Karten · cards · cartes
3x B6 Briefumschläge · envelopes · enveloppes
Grape



1193 1675 640/VE 6



30x A5 Blätter · sheets · feuilles, 120 g/m² Recycling Papier · Mit Perforation



Grape

1211 1675 640/VE 5



Muskat

1211 1675 625/VE 5



Zimt

1211 1675 641/VE 5



Anis

1211 1675 642/VE 5



Denim

1211 1675 629/VE 5



Kiwi

1211 1675 637/VE 5



TERRA NATURPAPIERE EDLES SCHREIBEN

10 Blätter · sheets · feuilles: 185 x 250 mm
10 Briefumschläge · envelopes · enveloppes: 192 x 95 mm (Ft. 7)
Grape



1173 1675 640/VE 5



10 Blätter · sheets · feuilles: 185 x 250 mm
10 Briefumschläge · envelopes · enveloppes: 192 x 95 mm (Ft. 7)
Kiwi



1173 1675 637/VE 5



10 Blätter · sheets · feuilles: 185 x 250 mm
10 Briefumschläge · envelopes · enveloppes: 192 x 95 mm (Ft. 7)
Flanell

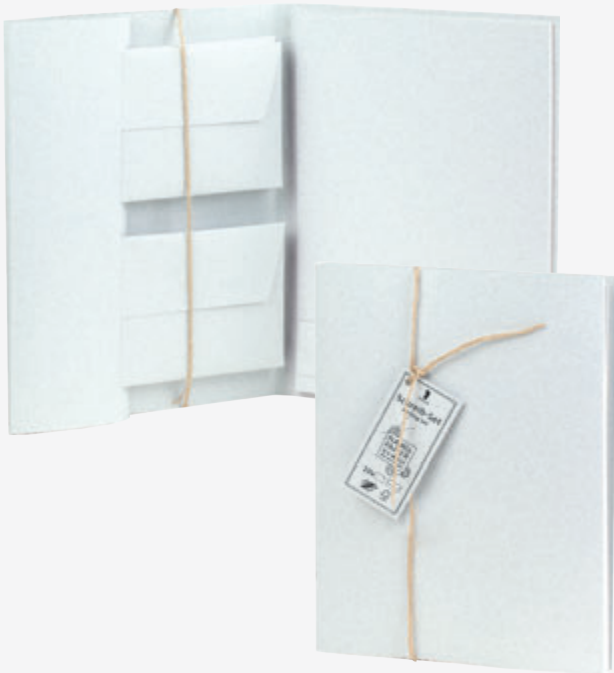

1173 1675 641/VE 5



10 Blätter · sheets · feuilles: 185 x 250 mm
10 Briefumschläge · envelopes · enveloppes: 192 x 95 mm (Ft. 7)
Mais



1173 1675 701/VE 5



EDLES SCHREIBEN DESIGNBLÖCKE

PRE-PRINTED PADS · BLOC DESIGNS

Designblöcke

40 bedruckte Blätter · printed sheets · feuilles imprimées



HEISSFOLIE
GOLD & SCHWARZ
Hot foil
Impression



HEISSFOLIE
SCHWARZ
Hot foil
Impression

GRASPAPIER
Grass paper
Papier d'herbe

DIN A4
1210 1968 000 / VE 5



DIN A5
1211 1968 001 / VE 5



20/DL
2032 1968 000 / VE 5



DIN A4
1210 1961 000 / VE 5



DIN A5
1211 1961 001 / VE 5



Designblöcke

25 bedruckte DIN A4 Blätter · printed sheets · feuilles imprimées



1210 805 000 / VE 5



1210 404 000 / VE 5



1210 524 000 / VE 5



15/DL, bedruckte Umschläge · printed envelopes · enveloppes imprimées



1231 805 000 / VE 5



1231 404 000 / VE 5



1231 524 000 / VE 5



Schreibsets

Writing sets

Sets de correspondance

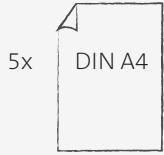

Hochwertiges
120 g/m² Naturpapier



Hochwertiges
100 g/m² Papier

NEU

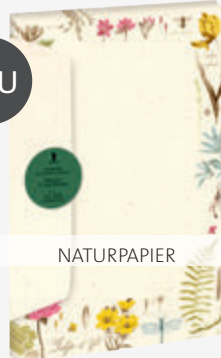

NATURPAPIER

1134 1688 800 / VE 5
4 014970 437663

NEU

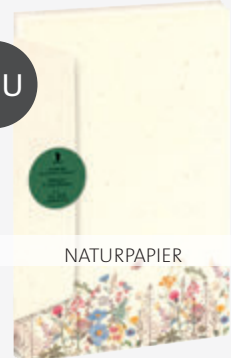

NATURPAPIER

1134 1960 800 / VE 5
4 014970 429392

NEU

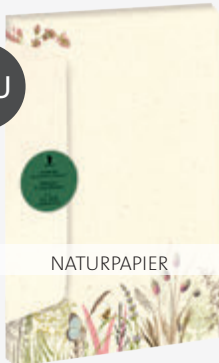

NATURPAPIER

1134 1689 800 / VE 5
4 014970 437670

NEU

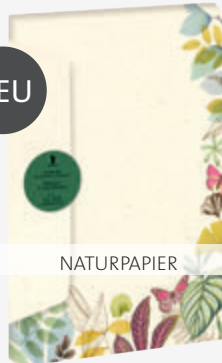

NATURPAPIER

1134 1690 800 / VE 5
4 014970 437687

NEU

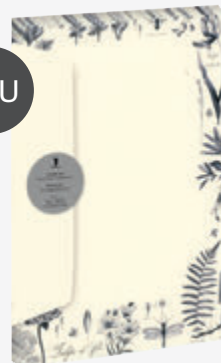

1134 1901 800 / VE 5
4 014970 409158

NEU

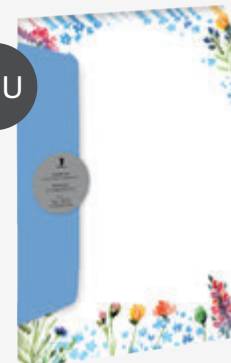

1134 1693 800 / VE 5
4 014970 437717

NEU



1134 1692 800 / VE 5
4 014970 437700

NEU

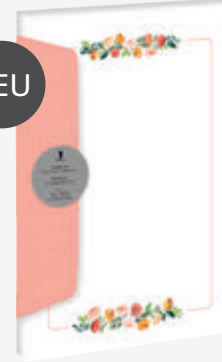

1134 1691 800 / VE 5
4 014970 437694



1134 1367 800 / VE 5
4 014970 216541



1134 1687 800 / VE 5
4 014970 384257



1134 1290 800 / VE 5
4 014970 172052



1134 1901 800 / VE 5
4 014970 409158



1134 1904 800 / VE 5
4 014970 409561



1134 1903 800 / VE 5
4 014970 409165

EDLES SCHREIBEN DESIGNPACKS

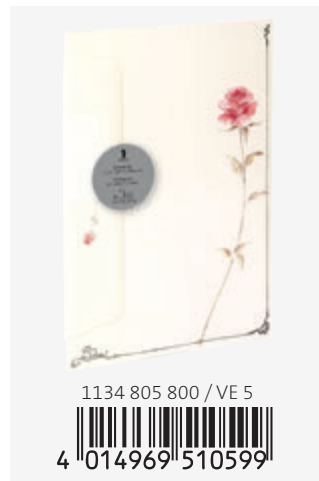

Designpacks
Hochwertiges
100 g/m² Papier

Premium paper 100 g/m²
Papier premium 100 g/m²



DIN A4

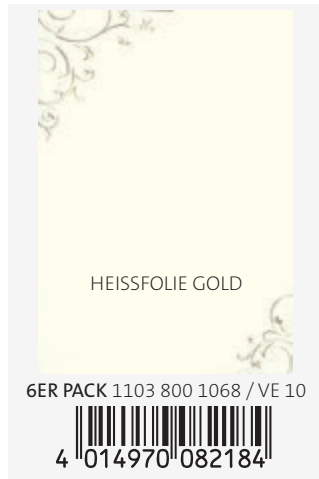
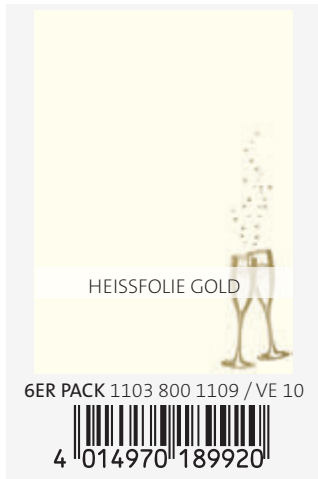
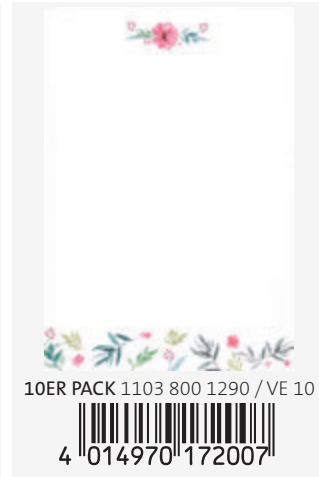

DER BELIEBTE KLASSIKER

Charmante Briefpapiermappen mit bedruckten Blättern und passenden Briefumschlägen.

Delightful stationery folders with printed sheets and matching envelopes.

Charmants dossiers de papeterie avec feuilles imprimées et enveloppes assorties.

1173 ...:

10 Blätter · sheets · feuilles: 185 x 250 mm

10 Briefumschläge · envelopes · enveloppes: 192 x 94 mm (Ft. 7)

NEU



1173 1977 000 / VE 5



4 014970 437953

NEU



1173 1966 000 / VE 5



4 014970 430114

NEU



1173 1967 000 / VE 5



4 014970 431067

NEU



1173 1955 000 / VE 5



4 014970 429026

NEU



1173 1960 000 / VE 5



4 014970 429408

NEU



1173 1964 000 / VE 5



4 014970 430015

EDLES SCHREIBEN BRIEFPAPIERPACKUNGEN

COMPENDIUMS · PAPIER À LETTRES



BRIEFPAPIERPACKUNGEN EDLES SCHREIBEN
 COMPENDIUMS · PAPIER À LETTRES



EDLES SCHREIBEN BRIEFPAPIERPACKUNGEN

COMPENDIUMS · PAPIER À LETTRES

DER BELIEBTE KLASSIKER

Charmante Briefpapiermappen mit bedruckten Blättern und passenden Briefumschlägen.

Delightful stationery folders with printed sheets and matching envelopes.

Charmants dossiers de papeterie avec feuilles imprimées et enveloppes assorties.

1173 ...:

10 Blätter · sheets · feuilles: 185 x 250 mm

10 Briefumschläge · enveloppes · enveloppes: 192 x 94 mm (Ft. 7)



1173 1936 000 / VE 5



1173 1938 000 / VE 5



1173 1916 000 / VE 5



BRIEFPAPIERPACKUNGEN EDLES SCHREIBEN

COMPENDIUMS · PAPIER À LETTRES



1170 1262 000 / VE 6

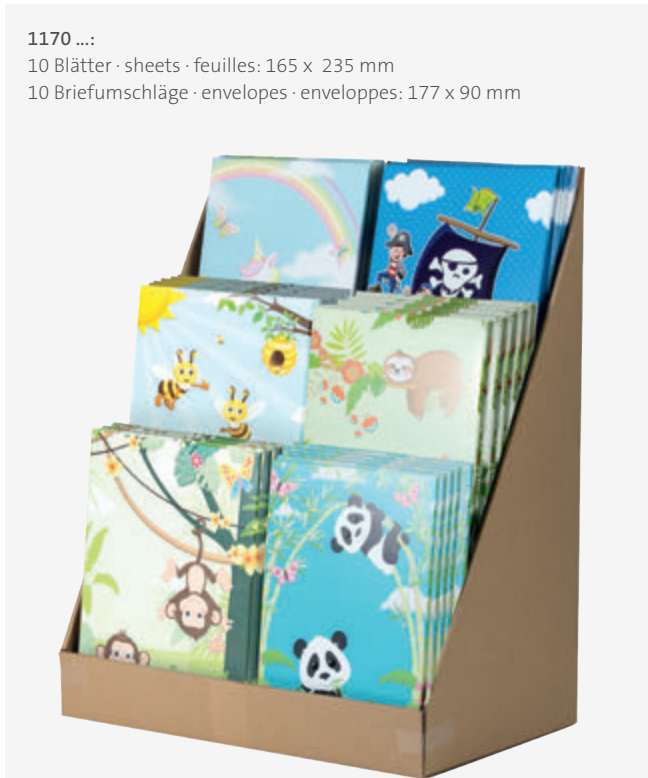

1170 ...:
10 Blätter · sheets · feuilles: 165 x 235 mm
10 Briefumschläge · envelopes · enveloppes: 177 x 90 mm

1170 2020 999 / VE 1



6 x 6 sortiert · assorted · assorties



1170 1620 000 / VE 6



1170 1622 000 / VE 6



1170 1163 000 / VE 6



1170 1330 000 / VE 6



1170 1407 000 / VE 6



EDLES SCHREIBEN BRIEFPAPIERPACKUNGEN

COMPENDIUMS · PAPIER À LETTRES

1170 ...:
 10 Blätter · sheets · feuilles: 165 x 235 mm
 10 Briefumschläge · envelopes · enveloppes: 177 x 90 mm



1170 1621 000 / VE 6



4 014970 237270



1170 1623 000 / VE 6



4 014970 367885



1170 989 000 / VE 6



4 014969 555767



1170 992 000 / VE 6



4 014969 555798



1170 987 000 / VE 6



4 014969 555743



1170 1108 000 / VE 6



4 014969 712801

5 Doppelkarten B6 quer, 220 g/m² gerippt
5 Briefumschläge B6, 100 g/m² gerippt
Heißfolie · hot foil · impression



FARBAUSWAHL

1181 955 008 / VE 6

CHAMOIS/GOLD



1181 955 063 / VE 6

ROSE/SILBER



1181 955 049 / VE 6

TAUPE/WEISS



1181 955 303 / VE 6

CANDLE LIGHT METALLIC/GOLD



1181 955 009 / VE 6

WEISS/SILBER



1181 955 022 / VE 6

MAIGRÜN/SILBER



1181 955 072 / VE 6

ROSSO/GOLD



1181 955 065 / VE 6

MINT/SILBER



5 Doppelkarten B6 quer, 220 g/m² gerippt
5 Briefumschläge B6, 100 g/m² gerippt
Heißfolie · hot foil · impression



1181 956 008 / VE 6

CHAMOIS/GOLD



1181 956 009 / VE 6

WEISS/SILBER



1181 956 303 / VE 6

CANDLE LIGHT METALLIC/GOLD



1181 956 022 / VE 6

MAIGRÜN/SILBER



1181 956 072 / VE 6

ROSSO/GOLD



EDLES SCHREIBEN FAVOURITE CARD BOXES

CARD BOXES · BOÎTES DE CARTES

Karten und Briefumschläge nach alter Handwerkskunst von Hand gerändert.
Hand-bordered cards and envelopes · Cartes et enveloppes bordées à la main

10/10 Karten/Briefumschläge · 85 x 128 mm / 90 x 140 mm



1828 206 075 / VE 4



1828 205 036 / VE 4



1828 206 090 / VE 4



1828 205 097 / VE 4



8/8, A6/C6, Crème
Heißfolie Gold



1821 1670 005 / VE 3



8/8, A6/C6, Crème
Heißfolie Gold



1821 1670 001 / VE 3



8/8, A6/C6, Crème
Heißfolie Gold



1821 1670 003 / VE 3



8/8, A6/C6, Weiß
Letterpress Grün



1821 1671 004 / VE 3



8/8, A6/C6, Weiß
Letterpress Orange



1821 1671 002 / VE 3



8/8, A6/C6, Weiß
Letterpress Pink



1821 1671 006 / VE 3



KLEINE FEINE

Für die kleinen besonderen Grüße.

For the small special greetings.

Pour les petits salutations spéciales.

Sets aus Karten und Briefumschlägen

card and envelope sets

pacquet de cartes et enveloppes

5 Einzelkarten · flat cards · cartes simples: 53 x 85 mm
5 Briefumschläge · enveloppes · enveloppes: 57 x 89 mm



Rot
1829 8095 036 / VE 8



Taupe
1829 8095 049 / VE 8



Tannengrün
1829 8095 097 / VE 8



Ivory
1829 8095 012 / VE 8



Metallic Gold
1829 8095 075 / VE 8



Metallic Silber
1829 8095 080 / VE 8



Weiß
1829 8095 009 / VE 8



Maigrün
1829 8095 022 / VE 8



Kraft
1829 8095 062 / VE 8



Rose
1829 8095 063 / VE 8



Mint
1829 8095 065 / VE 8



Hortensia
1829 8095 044 / VE 8



Eucalyptus
1829 8095 067 / VE 8





VERPACKEN & SCHENKEN STILVOLL FREUDE BEREITEN

So macht Schenken Freude! Die hochwertigen Kartonagen, Taschen und Geschenkpapiere werden die Augen der Beschenkten zum Leuchten bringen. Lassen Sie sich inspirieren!

With high-quality cardboard boxes, bags and wrapping paper from Rössler, giving presents is a joy!

Avec des boîtes, sacs et papiers cadeaux de qualité supérieure de Rössler, offrir fait plaisir!

BOXLINE HOCHWERTIGE KARTONAGEN

Vielfalt in Format und Farbe, Qualität und Nachhaltigkeit – das ist das Sortiment Boxline von Rössler. Hochwertige Kartonagen, die wir mit FSC®-zertifizierten Materialien herstellen. Erhältlich in vielfältigen Bestseller-Formaten.

The exclusive cardboard range:
The Rössler Boxline range features high-quality products in a diverse array of colours and sizes. We manufacture these quality cardboard boxes with FSC®-certified materials. They are available in a wide variety of best-selling formats.

La gamme de boîtes de haute qualité:
Diversité de format et de couleur, qualité et durabilité – telle est la gamme Rössler Boxline. Boîtes en carton de haute qualité que nous fabriquons avec des matériaux certifiés FSC®. Disponible dans une variété de formats best-seller.

15	Denim
36	Rot
49	Taupe
58	Powder
62	Kraft
65	Mint
70	Schwarz
90	Navy



65 x 65 x 65 mm
1342 1453 ..0 / VE 4



105 x 105 x 105 mm
1342 1453 ..1 / VE 4



215 x 155 x 30 mm
passend für A5
1352 1453 ..1 / VE 4



225 x 325 x 30 mm
passend für A4
1352 1453 ..0 / VE 4



BOXLINE VERPACKEN & SCHENKEN

15	Denim
36	Rot
49	Taupe
58	Powder
62	Kraft
65	Mint
70	Schwarz
90	Navy



96 x 128 x 40 mm
1340 1453 ..7 / VE 3



140 x 190 x 60 mm
1340 1453 ..5 / VE 3



196 x 264 x 80 mm
1340 1453 ..3 / VE 3

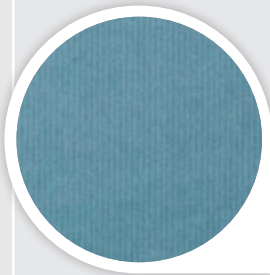

Bezug mit Rippenprägung
 ribbed cover material
 texture cannelée



2ER SATZ

220 x 300 x 120 mm
 250 x 350 x 140 mm
1349 1453 ..0 / VE 1



7ER SATZ

96 x 128 x 40 mm
 121 x 162 x 50 mm
 140 x 190 x 60 mm
 170 x 230 x 70 mm
 196 x 264 x 80 mm
 221 x 298 x 90 mm
 248 x 329 x 100 mm
1341 1453 ..0 / VE 1

VERPACKEN & SCHENKEN BOXLINE METALLIC

96 x 128 x 40 mm
121 x 162 x 50 mm
140 x 190 x 60 mm
170 x 230 x 70 mm
196 x 264 x 80 mm
221 x 298 x 90 mm
248 x 329 x 100 mm



Granat Metallic
1341 1453 530 / VE 1



4 014970 382604

Opal Metallic
1341 1453 520 / VE 1



4 014970 382529

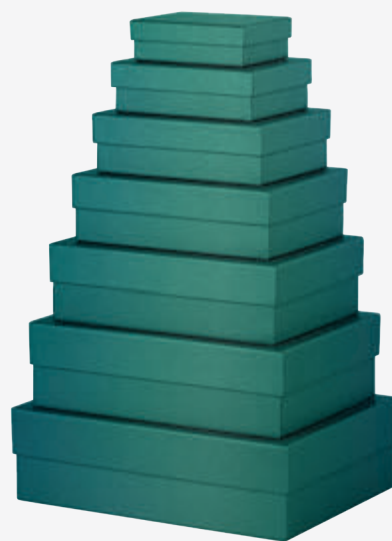

Gold Metallic
1341 1453 750 / VE 1



4 014970 382451



Silber Metallic
1341 1453 800 / VE 1



4 014970 382710



Kupfer Metallic
1341 1453 540 / VE 1



4 014970 382680



Milk Metallic
1341 1453 510 / VE 1



4 014970 382314



KARTONAGEN VERPACKEN & SCHENKEN

BOXES · BOÎTES

96 x 128 x 40 mm
121 x 162 x 50 mm
140 x 190 x 60 mm
170 x 230 x 70 mm
196 x 264 x 80 mm
221 x 298 x 90 mm
248 x 329 x 100 mm



Basic Rot
1341 1222 026 / VE 1



4 014970 102134



Basic Forest
1341 1222 071 / VE 1



4 014970 102141



Tilly Green
1341 1956 000 / VE 1



4 014970 430732



Lavendel
1341 1958 000 / VE 1



4 014970 429712



Dark Grey
1341 1965 000 / VE 1



4 014970 431128



1341 1950 000 / VE 1



4 014970 422157

VERPACKEN & SCHENKEN KARTONAGEN

BOXES · BOÎTES

95 x 125 x 40 mm
 120 x 160 x 50 mm
 145 x 195 x 60 mm
 170 x 230 x 70 mm
 195 x 265 x 80 mm



1343 1977 005 / VE 1



170 x 125 x 50 mm
 220 x 159 x 65 mm
 240 x 200 x 90 mm
 285 x 238 x 110 mm

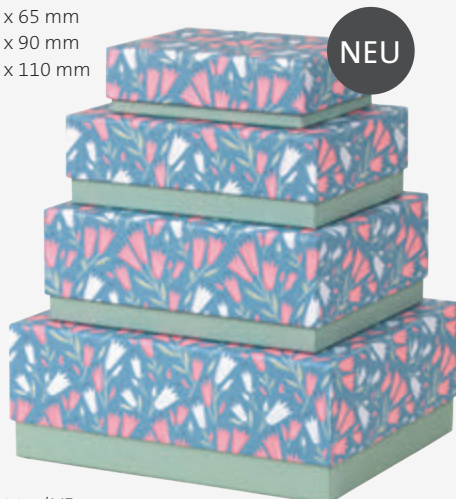

1343 1955 004 / VE 1



170 x 125 x 50 mm
 220 x 159 x 65 mm
 240 x 200 x 90 mm
 285 x 238 x 110 mm



1343 1960 004 / VE 1



170 x 125 x 50 mm
 220 x 159 x 65 mm
 240 x 200 x 90 mm
 285 x 238 x 110 mm



1343 1964 004 / VE 1



170 x 125 x 50 mm
 220 x 159 x 65 mm
 240 x 200 x 90 mm
 285 x 238 x 110 mm



Bornholm
 1343 1941 004 / VE 1



KARTONAGEN VERPACKEN & SCHENKEN

BOXES · BOÎTES

170 x 125 x 50 mm
 220 x 159 x 65 mm
 240 x 200 x 90 mm
 285 x 238 x 110 mm

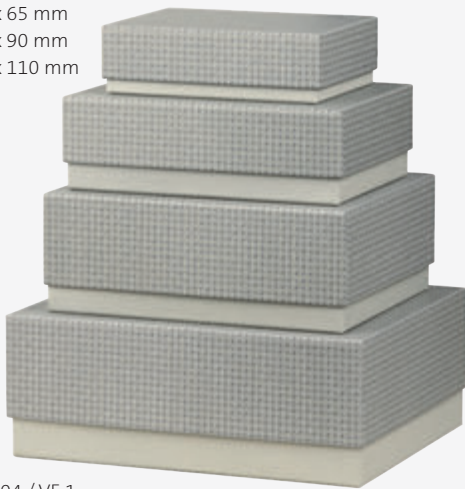

Basket

1343 1944 004 / VE 1



4 014970 418143

220 x 300 x 120 mm
 250 x 350 x 140 mm



1349 1964 000 / VE 1



4 014970 429798

170 x 125 x 50 mm
 220 x 159 x 65 mm
 240 x 200 x 90 mm
 285 x 238 x 110 mm

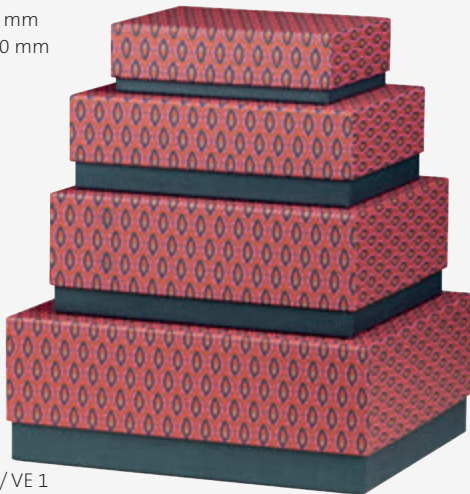

Cosima

1343 1945 004 / VE 1



4 014970 419768

170 x 125 x 50 mm
 220 x 159 x 65 mm
 240 x 200 x 90 mm
 285 x 238 x 110 mm



Francesca

1343 1947 004 / VE 1



4 014970 418570



VERPACKEN & SCHENKEN KARTONAGEN

BOXES · BOÎTES

95 x 125 x 40 mm
 120 x 160 x 50 mm
 145 x 195 x 60 mm
 170 x 230 x 70 mm



1341 7191 400 / VE 1



95 x 125 x 40 mm
 120 x 160 x 50 mm
 145 x 195 x 60 mm
 170 x 230 x 70 mm



1341 7170 400 / VE 1



240 x 200 x 90 mm



1343 1928 200 / VE 2



240 x 200 x 90 mm



1343 1930 200 / VE 2



190 x 140 x 60 mm



1343 1928 100 / VE 2



190 x 140 x 60 mm



1343 1930 100 / VE 2



60 x 87 x 50 mm



1354 1928 000 / VE 4



60 x 87 x 50 mm



1354 1930 000 / VE 4



KARTONAGEN VERPACKEN & SCHENKEN

BOXES · BOÎTES

NEU

HEISSFOLIE
GOLD
Hot foil
Impression

1347 1956 006 / VE 4

(2+2)
126 x 96 x 40 mm
Heißfolie Gold · hot foil · avec impression

4 014970 429330

NEU

HEISSFOLIE
SCHWARZ
Hot foil
Impression

„For you“

1347 1958 006 / VE 4

(2+2)
126 x 96 x 40 mm
Heißfolie Schwarz · hot foil · avec impression

4 014970 429927

200 x 55 x 30 mm

Stiftebox mit Gummizug
Heißfolie Schwarz

1358 3300 000 / VE 4

4 014970 399381

140 x 190 x 60 mm

NEU

Rose

1352 1192 633 / VE 3

4 014970 191626

140 x 190 x 60 mm

NEU

Eucalyptus

1352 1192 673 / VE 3

4 014970 438363

140 x 190 x 60 mm

Powder Metallic

1352 1190 004 / VE 3

4 014970 247552

140 x 190 x 60 mm

Taupe Metallic

1352 1191 003 / VE 3

4 014970 190148

140 x 190 x 60 mm

Terra Vanilla

1352 1192 023 / VE 3

4 014970 247521

140 x 190 x 60 mm

Kraft

1352 1192 623 / VE 3

4 014970 191619

140 x 190 x 60 mm

Terra Denim

1352 1192 626 / VE 3

4 014970 247569

140 x 190 x 60 mm

Cotton

1352 1192 627 / VE 3

4 014970 247576

VERPACKEN & SCHENKEN SAMMELBOXEN
COLLECTION BOXES · BOÎTES URNES

205 x 195 x 150 mm



1340 311 460 / VE 2



1340 311 220 / VE 2



1340 311 012 / VE 2



205 x 195 x 150 mm



1340 7157 000 / VE 2



205 x 195 x 150 mm



1340 7150 000 / VE 2



205 x 195 x 150 mm



1340 7191 000 / VE 2



170 x 320 x 200 mm



1340 822 000 / VE 1



NEU

GESCHENKPAPIER VERPACKEN & SCHENKEN
WRAPPING PAPER · PAPIER CADEAU



1405 1960 000 / VE 15



15x in Dekor-Box
pro Rolle 2 Bogen
500 x 700 mm

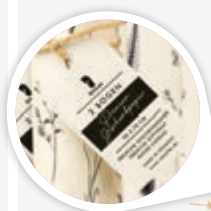

1405 1964 000 / VE 15



15x in Dekor-Box
pro Rolle 2 Bogen
500 x 700 mm



1401 1960 000 / VE 15



500 x 700 mm



1401 1964 000 / VE 15



500 x 700 mm

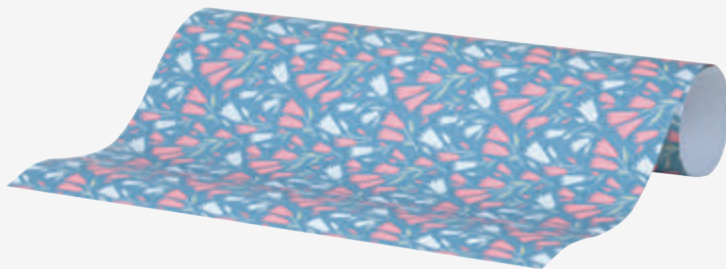

1401 1955 000 / VE 15



500 x 700 mm



1401 1977 000 / VE 15



500 x 700 mm

VERPACKEN & SCHENKEN GESCHENKPAPIER

WRAPPING PAPER · PAPIER CADEAU

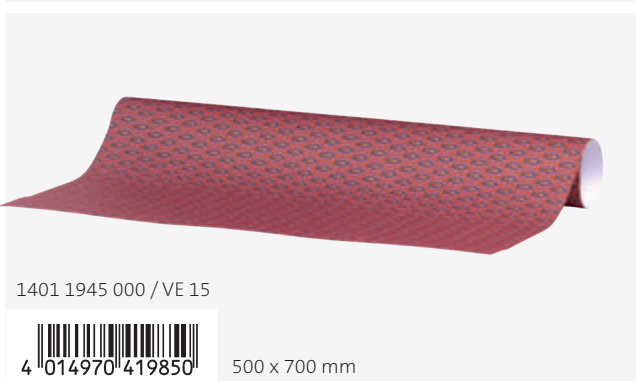
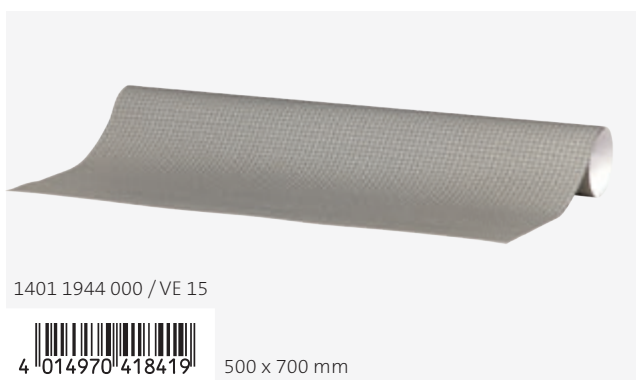
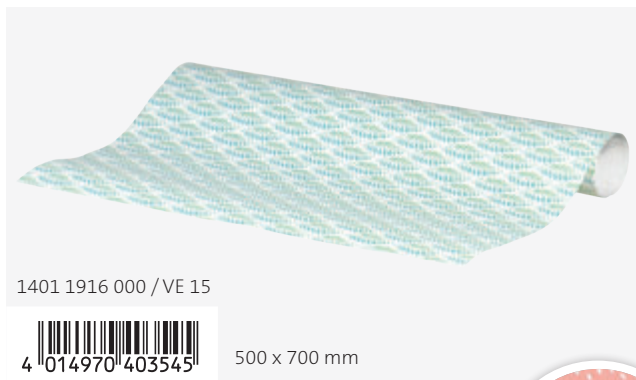

GESCHENKPAPIER VERPACKEN & SCHENKEN

WRAPPING PAPER · PAPIER CADEAU

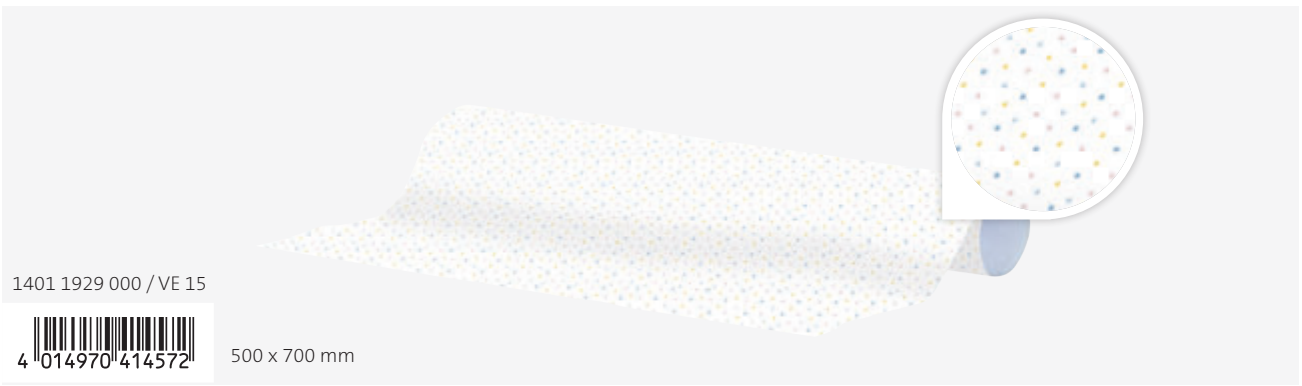
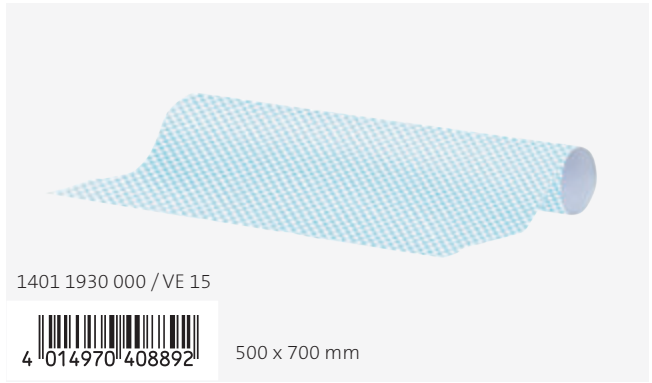
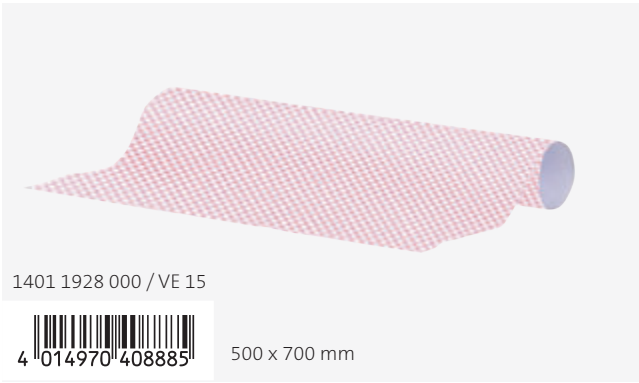
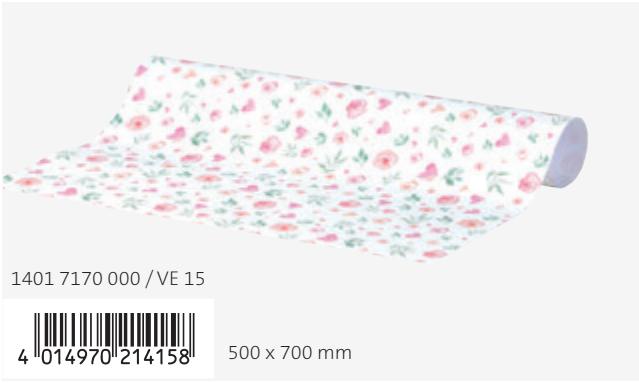

VERPACKEN & SCHENKEN GESCHENKTASCHEN

GIFT BAGS · SACS CADEAUX

120 x 120 x 60 mm



1366 7191 000 / VE 6



4 014970 385964

220 x 230 x 80 mm



1368 7191 000 / VE 6



4 014970 381218

230 x 190 x 80 mm



1364 7170 000 / VE 6



4 014970 214486



1364 7170 7166 / VE 6



4 014970 214134



1364 7170 7167 / VE 6



4 014970 214141

120 x 120 x 60 mm



1366 1928 000 / VE 8



4 014970 411311

230 x 190 x 80 mm



1368 1928 000 / VE 8



4 014970 408861

120 x 120 x 60 mm



1366 1930 000 / VE 8



4 014970 411328

230 x 190 x 80 mm



1368 1930 000 / VE 8



4 014970 408878

NEU

GESCHENKTASCHEN VERPACKEN & SCHENKEN
GIFT BAGS · SACS CADEAUX

230 x 220 x 85 mm



1368 1977 000 / VE 8



190 x 260 x 80 mm



1365 1955 000 / VE 8



110 x 150 x 65 mm

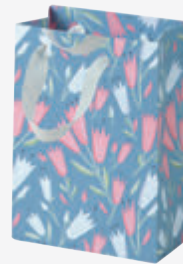

1366 1955 000 / VE 8



230 x 220 x 85 mm



1368 1960 000 / VE 8



230 x 220 x 85 mm



1368 1964 000 / VE 8



VERPACKEN & SCHENKEN GESCHENKTASCHEN
GIFT BAGS · SACS CADEAUX

NEU

180 x 230 x 100 mm
mit Heißfolie Gold

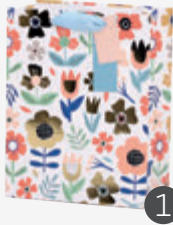

1

1369 1980 000 / VE 10



4 014970 436734

260 x 320 x 125 mm
mit Heißfolie Gold



2

1366 1980 000 / VE 10



4 014970 436741

180 x 230 x 100 mm
mit Glitter



3

1369 1981 000 / VE 10



4 014970 436765

260 x 320 x 125 mm
mit Glitter

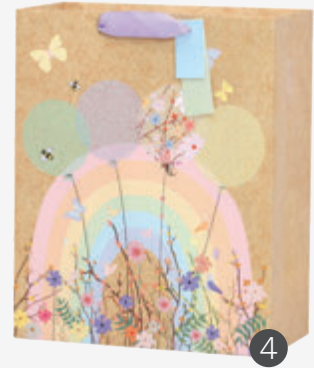

4

1366 1981 000 / VE 10



4 014970 436758

180 x 230 x 100 mm
mit Glitter

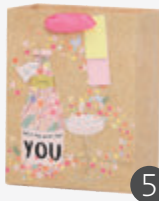

5

1369 1982 000 / VE 10



4 014970 436789

260 x 320 x 125 mm
mit Glitter

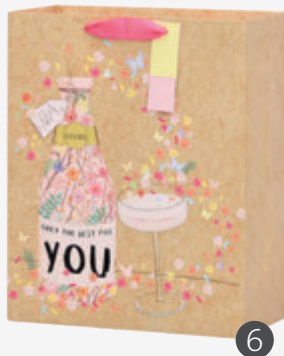

6

1366 1982 000 / VE 10



4 014970 436772

230 x 230 x 125 mm



7

1368 1984 000 / VE 10



4 014970 436802

230 x 230 x 150 mm



8

1368 1983 000 / VE 10



4 014970 436796

210 x 255 x 100 mm
mit Glitter



9

1369 1985 000 / VE 10



4 014970 436840

260 x 320 x 120 mm
mit Glitter



10

1366 1985 000 / VE 10



4 014970 436833

210 x 255 x 100 mm
mit Glitter



11

1369 1986 000 / VE 10



4 014970 436826

260 x 320 x 120 mm
mit Glitter



12

1366 1986 000 / VE 10



4 014970 436819

GESCHENKTASCHEN VERPACKEN & SCHENKEN

GIFT BAGS · SACS CADEAUX

LET'S CELEBRATE – SORTIERUNG (TASCHEN 1–12)
LET'S CELEBRATE – ASSORTMENT (BAGS 1–12)
LET'S CELEBRATE – ASSORTIMENT (SACS 1–12)

1000 1980 000 / VE 1

120 Taschen · bags · sacs
10 Stück pro Motiv · 10 pieces per each
motif · 10 pièces par motif



VERPACKEN & SCHENKEN GESCHENKTASCHEN & FLASCHENBEUTEL

GIFT BAGS & BOTTLE BAGS · SACS CADEAUX & SACS POUR BOUTEILLES

GOLDEN MOMENTS – SORTIERUNG (TASCHEN 1–6)
GOLDEN MOMENTS – ASSORTMENT (BAGS 1–6)
GOLDEN MOMENTS – ASSORTIMENT (SACS 1–6)

1000 1921 000 / VE 1

60 Taschen · bags · sacs

2 Motive in 3 Formaten, je 10 Stk.



4 014970 405402



1

180 x 230 x 100 mm
mit Heißfolie
1369 1920 000 / VE 10



4 014970 405365



2

260 x 320 x 120 mm
mit Heißfolie
1366 1920 000 / VE 10



4 014970 405358



3

120 x 390 x 90 mm
mit Heißfolie
1363 1920 000 / VE 10



4 014970 405341



4

180 x 230 x 100 mm
mit Heißfolie
1369 1921 000 / VE 10



4 014970 405396



5

260 x 320 x 120 mm
mit Heißfolie
1366 1921 000 / VE 10



4 014970 405389

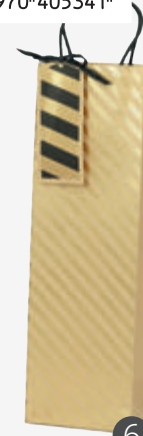

6

120 x 390 x 90 mm
mit Heißfolie
1363 1921 000 / VE 10



4 014970 405372



GESCHENKTASCHEN VERPACKEN & SCHENKEN

GIFT BAGS · SACS CADEAUX

HAPPY TIMES – SORTIERUNG (TASCHEN 7–16)
 HAPPY TIMES – ASSORTMENT (BAGS 7–16)
 HAPPY TIMES – ASSORTIMENT (SACS 7–16)

1000 1922 000 / VE 1

100 Taschen · bags · sacs
 5 Motive in 2 Formaten, je 10 Stk.



7

310 x 260 x 120 mm
 1366 1926 000 / VE 10



8

420 x 310 x 120 mm
 1362 1926 000 / VE 10



9

180 x 230 x 100 mm
 mit Glitter
 1369 1922 000 / VE 10



10

260 x 320 x 120 mm
 mit Glitter
 1366 1922 000 / VE 10



11

180 x 230 x 100 mm
 mit Heißfolie + Glitter
 1369 1923 000 / VE 10



12

260 x 320 x 120 mm
 mit Heißfolie + Glitter
 1366 1923 000 / VE 10

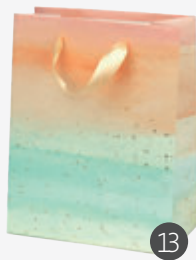

13

180 x 230 x 100 mm
 mit Heißfolie
 1369 1924 000 / VE 10

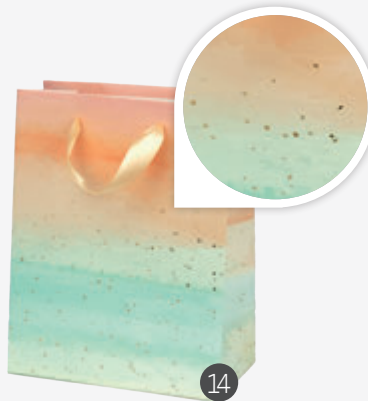

14

260 x 320 x 120 mm
 mit Heißfolie
 1366 1924 000 / VE 10



15

180 x 230 x 100 mm
 mit Heißfolie
 1369 1925 000 / VE 10



16

260 x 320 x 120 mm
 mit Heißfolie
 1366 1925 000 / VE 10



KONTAKTE CONTACTS

Germany

Rössler Papier GmbH & Co. KG
Valenciennr Straße 56
D-52355 Düren
Telephone +49 (0) 24 21 69 01 0
Telefax +49 (0) 24 21 69 01 500
E-Mail info@roessler.eu
www.roessler.eu

France

Rössler France
482 Chemin de Beauregard
F-13630 Eyragues
Telephone +33 (0) 4 90 24 96 92
Telefax +33 (0) 4 90 24 96 85
E-Mail quinton@roesslerpapier.fr

Switzerland

Buchzentrum AG (BZ)
Industriestr. Ost 10
CH-4614 Hägendorf
Telephone +41 (0) 62 209 2525
Telefax +41 (0) 62 209 2627
E-Mail tomato@buchzentrum.ch
www.buchzentrum.ch

Austria

Cardcompany
Andreas Auer GmbH
Esterhazystraße 28
A-2486 Pottendorf
Telephone +43 (0) 26 23 75 75 2
Telefax +43 (0) 26 23 75 75 2 9
E-Mail roessler@cardcompany.at
www.cardcompany.at

Hungary

Pirex 98 Kft.
Torbágy utca 18
H-2045 Törökbálint
Telephone +36 (0) 23 51 16 00
Telefax +36 (0) 23 51 16 01
E-Mail info@pirex.hu
www.pirex.hu

All other countries

Rössler Papier GmbH & Co. KG
Valenciennr Straße 56
D-52355 Düren
Telephone +49 (0) 24 21 69 01 244
Telefax +49 (0) 24 21 69 01 532
E-Mail info@roessler.eu
www.roessler.eu

Belgium, Luxembourg & The Netherlands

Eurostyle PGmbH
Robert Creutz
Rue Mitoyenne 350
B-4710 Lontzen
Telephone +32 (0) 87 65 92 88
Telefax +32 (0) 87 65 87 28
E-Mail info@eurostyle.be
www.eurostyle.be

Italy

PBS-EURO-SERVICE SRL-GmbH
Reifstraße 7, Via Reif 7
I-39044 Laag bei Neumarkt (BZ)
I-39044 Laghetti di Egna (BZ)
Telephone +39 (0) 4 71 81 86 81
Telefax +39 (0) 4 71 81 86 74
E-Mail info@pbs-euro-service.com
www.pbs-euro-service.com

Czech Republic

Omega-Horovice Spol. s.r.o
Pod Nadrazim 1413
CZ-268 01 Horovice
Telephone +42 (0) 3 11 51 00 51
Telefax +42 (0) 3 11 51 02 11
E-Mail info@omega-convert.com
www.omega-convert.com

Spain

Grupo Erik Editores S.R.L.
P. Ind. EL Vadillo – c/Santo Domingo 31
E-18600 Motril (Granada)
Telephone +34 (0) 9 58 61 06 72
Telefax +34 (0) 9 58 61 06 82
E-Mail info@grupoerik.com
www.grupoerik.com



PAPIERVERLIEBT SEIT 1937. STILSICHER IN NEUE ZEITEN.

IN LOVE WITH PAPER FOR GENERATIONS. INTO THE FUTURE WITH STYLE.
AMOUREUX DU PAPIER DEPUIS DES GÉNÉRATIONS. AVEC STYLE DANS UNE ÈRE NOUVELLE.



7023-1111

Sprechen Sie uns gerne
auf unsere zertifizierten
Produkte an.



Das Zeichen für
verantwortungsvolle
Waldwirtschaft

RÖSSLER PAPIER GMBH & CO. KG

VALENCIENNER STRASSE 56 · 52355 DÜREN · T +49 2421. 6901-0 · F +49 2421. 6901-500 · INFO@ROESSLER.EU · WWW.ROESSLER.EU